

K4610X

| | |
|--------------------|-------------------------------------------------------------------------|
| Product family | Hoods |
| Subfamily | Condensation |
| Hood Type | Mounted on oven |
| Design | Angled |
| Tecnology | Suction and filtering hood |
| Extraction | Recirculation |
| Electronic control | Yes |
| Suitable for | Combined oven 5 trays GN1/1 ; Convection ovens 600x400 mm - GN1/1 |
| Material | Stainless steel |
| Type of steel | Polished |
| Hood width | 80 cm |



Aesthetics

| | | | |
|----------------------|-----------------|------|----------|
| Colour | Stainless steel | Logo | Embossed |
| Components finishing | Stainless steel | | |

Controls

| | | | |
|-----------------|-------------------------------------|-----------|-------|
| Control setting | Touch control back-lighted White | Led color | White |
|-----------------|-------------------------------------|-----------|-------|

Technical Features



| | | | |
|------------------------------|-----------------------|-----------------------------------|--------|
| No. of lights | 1 | Charcoal filters included | Yes |
| Light type | LED | No. of filters | 2 |
| Light Power | 1,1 W | Filter replacement indicator | Yes |
| Dimmer mode | Yes | Vent outlet | 150 mm |
| Free outlet maximum capacity | 900 m ³ /h | Non return valve | Yes |
| Anti-grease filters | Buffle | Light color temperature scale (K) | 4000 K |
| Motor power | 330 W | | |

Electrical Connection

| | | | |
|----------------|-----------|---------------------------|---------|
| Voltage | 220-240 V | Power supply cable length | 1500 mm |
| Frequency (Hz) | 50-60 Hz | | |

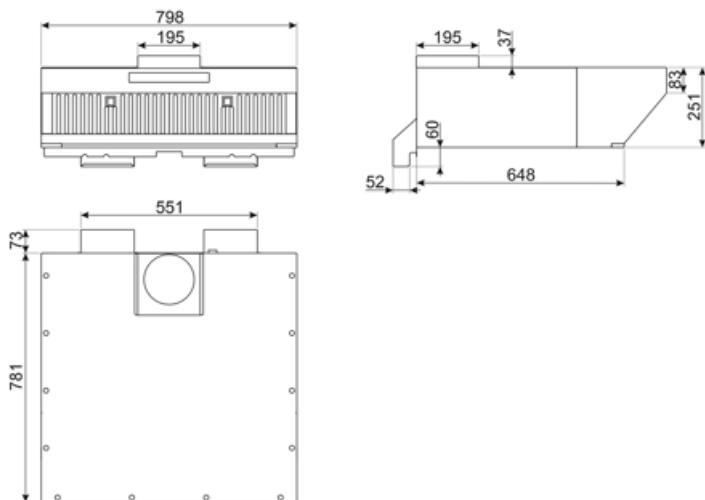

Logistic Information

| | | | |
|------------------------------------------|----------------|---------------------|-----------|
| EAN code | 8017709314446 | Net weight | 19,810 kg |
| Packed product dimensions (WxDxH) | 798x854x251 mm | Gross weight | 24,230 kg |

Compatible Accessories

FLT6

Round Charcoal filters (kit 2 pieces)



KITCMNKVX









Chimney Extension in Stainless Steel for hood KV*series Dimensions 300x200x850 mm



KITALLFC

Universal Charcoal filter Stainless Steel AISI 304 The filter can be washed in dishwasher 50 °C (water and suitable detergent) and to dry it put in the oven 180°C 25 minutes

Symbols glossary

- | | | | |
|----------------------------------------------------------------------------------|-----------------------------------------------------------------------------------------------------------------------------------------------------------|-----------------------------------------------------------------------------------|-------------------------------------------------------------------------------------------------------------------------------|
|  | 24h: When selected this function refreshes the air for c. 10 minutes every hour over a 24 hour period, at minimum speed and an imperceptible noise level. |  | Filters: Model has filters to help remove grease from the steam emanating from the pans during cooking. |
|  | Switch off automatically: A special setting, to run after the end of cooking for a pre-set time and then switch off automatically. |  | Charcoal filters: Extracting through charcoal filters or directly to the exterior lessens strong cooking odours considerably. |
|  | Warning light(s): to advise when filters need changing. |  | Lights: All cooker hoods feature lights to illuminate the cooking area or add to the ambience of the kitchen. |
|  | Intensive/turbo setting: when extra fast extraction is required. |  | Dimmering Lights |