

# KBT1200XE

Product family	Hood
Hood Type	Decorative wall hood
Design	T flat
Extraction	Extraction
Electronic control	Yes
Material	Stainless steel
Type of steel	Brushed
EAN code	8017709286637
Hood width	120 cm



## Aesthetics

Aesthetic Colour	Universale Stainless steel	Finishing Logo	Satin Silk screen
------------------	-------------------------------	----------------	----------------------

## Controls

Control setting	Electronic buttons
-----------------	--------------------

## Technical Features



No. of lights	2	Anti-grease filters	Aluminium
Light type	LED	Filter replacement indicator	Yes
Light Power	1.3 W	Vent outlet	150 mm
Light color temperature scale (°K)	3000 °K	Minimum distance from GAS hob	650 mm
Free outlet maximum capacity	610 m³/h	Minimum distance from ELECTRIC hob	650 mm
Motor power	230 W	Non return valve	Yes
No. of filters	4		

	Extraction rate IEC 61591 [m³/h]	Noise level IEC 60704-2-13 [dBA]
Speed 1	251	48
Speed 2	345	56

Speed 3	454	62
Intensive speed	690	72

## Accessories Included

Tube reduction Yes

## Performance / Energy Label



Annual Efficiency Consumption (AEChood)	55 kWh/a	Airborne acoustical A-weighted sound Power Emission at maximum speed (SPEmax)	61 dBA
Energy efficiency class (EEC)	A	Airbourne acoustical A-weighted sound power emission at boost speed (SPEboost)	71 dBA
Fluid Dynamic Efficiency (FDE)	30,2	Power consumption in stand-by mode (Ps)	0,23 W
Fluid Dynamic Efficiency class (FDEC)	A	Time increase factor (F)	0,9
Lighting Efficiency (LE)	58,8 lux/W	Energy Efficiency Index	52,1
Lighting Efficiency Class (LEC)	A	Measured air flow rate at best efficiency point (Qbep)	387 m³/h
Grease Filtering Efficiency (GFE)	79,6 %	Measured air pressure at best efficiency point (Pbep)	452 Pa
Grease Filtering Efficiency Class (GFEC)	C	Measured electric power input at best efficiency point (Wbep)	161 W
Air flow at minimum speed (Qmin)	251 m³/h	Nominal Power consumption of the light system (WL)	3 W
Air flow at maximum speed (Qmax)	454 m³/h	Average illumination of the light on the cooking surface (Emiddle)	153 lux
Air flow at boost speed (Qboost)	690 m³/h	Sound power level at highest setting (Lwa)	72 dBA
Airbourne acoustical A-weighted sound Power Emission at minimum speed (SPEmin)	47 dBA		

## Electrical Connection

Plug	Not present	Frequency (Hz)	50-60 Hz
Electrical connection rating	230 W	Power supply cable length	1500 mm
Voltage	220-240 V		

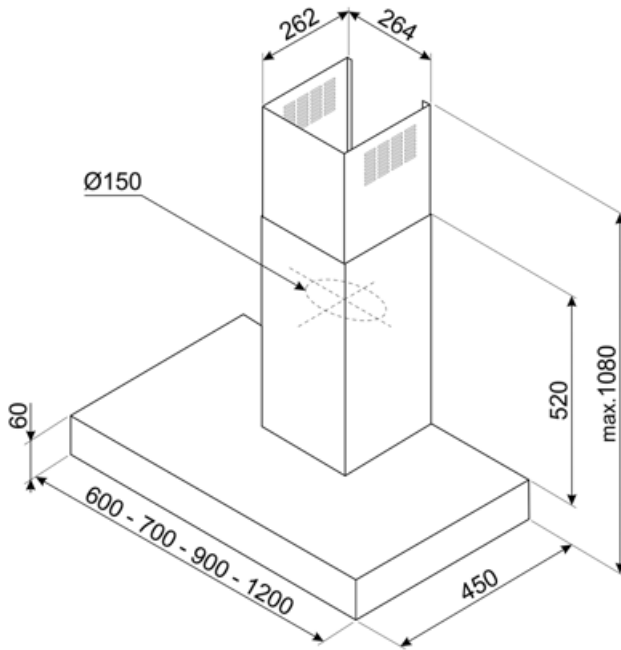

---

## Not included accessories

---

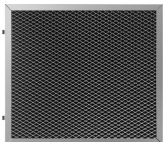

### KITFCKBT

1 pcs di filtro a carboni attivi per i modelli di cappe KBT\* / KBCT\*

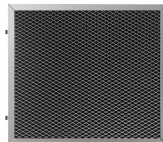

### KITFCKBTR

1 pcs of Charcoal filter Regenerable\* suitable for all the KBT/KBCT models.  
\* It can be washed in the dishwasher up to 12 times and dry in the oven at max 90° for 60 min. dimension 237,5(H)x245x10 mm









### KITCEKBT

Chimney extension, dimensions 261,5 \* 260 \* 830 mm suitable for T-shape hood KBT\* & KBCT\*, max hight 1380 mm Stainless Steel

---

## Symbols glossary (TT)

---

- |  |   |   |   |
|--|---|---|---|
|  | 24h: When selected this function refreshes the air for c. 10 minutes every hour over a 24 hour period, at minimum speed and an imperceptible noise level. |  | Filters: Model has filters to help remove grease from the steam emanating from the pans during cooking.       |
|  | Switch off automatically: A special setting, to run after the end of cooking for a pre-set time and then switch off automatically.                        |  |   |
|  | Warning light(s): to advise when filters need changing.   |  | Lights: All cooker hoods feature lights to illuminate the cooking area or add to the ambience of the kitchen. |
|  | Intensive/turbo setting: when extra fast extraction is required.  |   |   |