

# KBT600VE

<b>Product family</b>	Hood
<b>Hood Type</b>	Decorative wall hood
<b>Design</b>	T flat
<b>Extraction</b>	Extraction
<b>Electronic control</b>	Yes
<b>Material</b>	Stainless Steel + Glass
<b>Type of steel</b>	Brushed
<b>EAN code</b>	8017709289713
<b>Hood width</b>	60 cm
<b>Aesthetic</b>	Universale
<b>Colour</b>	Stainless Steel and Glass
<b>Finishing</b>	Satin
<b>Logo</b>	Silk screen



## Controls

<b>Control setting</b>	Electronic buttons
------------------------	--------------------

## Program / Functions

<b>No. of speeds</b>	3
<b>Intensive speed</b>	
<b>24h air filter function</b>	
<b>Time-setting options</b>	

## Technical Features



<b>No. of lights</b>	2	<b>Anti-grease filters</b>	Aluminium
<b>Light type</b>	LED	<b>Filter replacement indicator</b>	Yes
<b>Light Power</b>	1,3 W	<b>Vent outlet</b>	150 mm
<b>Light color temperature scale (K)</b>	3000 K	<b>Minimum distance from GAS hob</b>	650 mm
<b>Free outlet maximum capacity</b>	730 m <sup>3</sup> /h	<b>Minimum distance from ELECTRIC hob</b>	500 mm
<b>Motor power</b>	230 W	<b>Non return valve</b>	Yes
<b>No. of filters</b>	1		

	Extraction rate IEC 61591 [m <sup>3</sup> /h]	Noise level IEC 60704-2-13 [dBA]
Speed 1	243	48
Speed 2	332	55
Speed 3	451	62
Intensive speed	677	71

## Accessories included

Tube reduction Yes

## Performance / Energy Label



Annual Efficiency Consumption (AEChood)	60 kWh/a	Airbourne acoustical A-weighted sound Power Emission at minimum speed (SPEmin)	47 dBA
Energy efficiency class (EEC)	B	Airborne acoustical A-weighted sound Power Emission at maximum speed (SPEmax)	61 dBA
Fluid Dynamic Efficiency (FDE)	29,1	Airbourne acoustical A-weighted sound power emission at boost speed (SPEboost)	70 dBA
Fluid Dynamic Efficiency class (FDEC)	A	Time increase factor (F)	1,0
Lighting Efficiency (LE)	68,5 lux/W	Energy Efficiency Index	57,4
Lighting Efficiency Class (LEC)	A	Measured air flow rate at best efficiency point (Qbep)	433 m <sup>3</sup> /h
Grease Filtering Efficiency (GFE)	81,1 %	Measured air pressure at best efficiency point (Pbep)	451 Pa
Grease Filtering Efficiency Class (GFEC)	C	Measured electric power input at best efficiency point (Wbep)	158 W
Air flow at minumum speed (Qmin)	243 m <sup>3</sup> /h	Nominal Power consumption of the light system (WL)	3 W
Air flow at maximum speed (Qmax)	451 m <sup>3</sup> /h	Average illumination of the light on the cooking surface (Emiddle)	178 lux
Air flow at boost speed (Qboost)	677 m <sup>3</sup> /h	Sound power level at highest setting (Lwa)	62 dBA

## Electrical Connection

Electrical connection rating	233 W	Power supply cable length	1500 mm
Voltage	220-240 V	Plug	Not present
Frequency (Hz)	50-60 Hz		

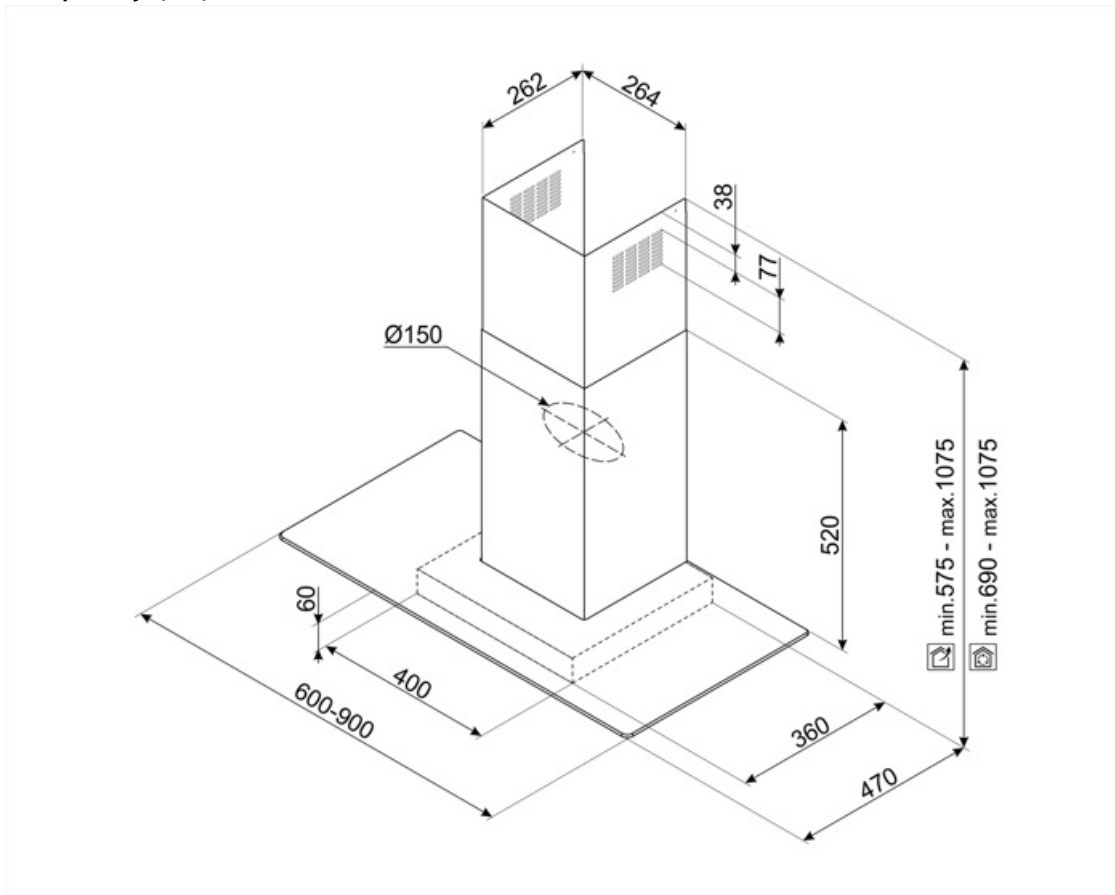

---

## Compatible Accessories

---



### KITCEKBT

Chimney extension, dimensions 261,5 \* 260 \* 830 mm suitable for T-shape hood KBT\* & KBCT\*, max height 1380 mm Stainless Steel



### KITFCKBT

1 pc of charcoal filter for the hood models KBT\* / KBCT\*









### KITFCKBTR

1 pcs of Charcoal filter Regenerable\* suitable for all the KBT/KBCT models. \* It can be washed in the dishwasher up to 12 times and dry in the oven at max 90° for 60 min. dimension 237,5(H)x245x10 mm

---

## Symbols glossary

---

- |  |   |   |   |
|--|---|---|---|
|  | 24h: When selected this function refreshes the air for c. 10 minutes every hour over a 24 hour period, at minimum speed and an imperceptible noise level. |  | Filters: Model has filters to help remove grease from the steam emanating from the pans during cooking. |
|  | Switch off automatically: A special setting, to run after the end of cooking for a pre-set time and then switch off automatically.                        |  | Warning light(s): to advise when filters need changing.   |
|  | Lights: All cooker hoods feature lights to illuminate the cooking area or add to the ambience of the kitchen.   |  | Intensive/turbo setting: when extra fast extraction is required.  |
|  |   |   |   |