

KBT900NE



Product familie	Dampkap
Type dampkap	Decoratieve muurdampkap
Type dampkap	T-vorm plat
Extractie	Extractie
Elektronische bediening	Ja
Materiaal	Gelakt materiaal
Type staal	Geborsteld inox
EAN-code	8017709299811
Breedte dampkap	90 cm
Design	Universeel
Kleur	Mat zwart
Afwerking	Mat
Logo	Geëtst



Bediening

Bediening	Elektronische toetsen
-----------	-----------------------

Program / Functions

Aantal snelheden	3
Snelheid Intensief	
Luchtzuiveringsfunctie (24 uur)	
Automatische uitschakeling	

Technische specificaties

				
Aantal lampen	2	Vetfilters	Aluminium	
Type lamp	LED	Indicator vervangen filter	Ja	
Vermogen lamp	1,3 W	Diameter ventilatie outlet	150 mm	
Temperatuur licht (Kelvin)	3000 K	Minimum afstand van gaskookplaat	650 mm	
Capaciteit P0	820 m ³ /h	Minimum afstand van elektrische kookplaat	500 mm	
Vermogen motor	230 W	Terugslagklep	Ja	
Aantal filters	3			

	Capaciteit niveau 1 (IEC 61591) [m ³ /h]	Geluidsniveau niveau 1 (IEC 60704-2-13) [dBA]
Snelheid 1	265	47
Snelheid 2	360	55
Snelheid 3	480	62
Snelheid Intensief	713	72

Meegeleverde accessoires

Reductie pijp Ja

Prestaties / energielabel



Jaarlijkse energieconsumptie (AEC)	53 kWh/jaar	Akoestische geluidsdruk op minimum snelheid (SPEmin)	48 dBA
Energie-efficiëntieklasse (EEC)	A	Akoestische A-gewogen geluidsemmissie op maximum snelheid	64 dBA
Hydrodynamische efficiëntieklasse (FDE)	29,8	Akoestische A-gewogen geluidsvermogens in de lucht met intensieve snelheid	71 dBA
Hydrodynamische efficiëntieklasse (FDEC)	A	Tijdverhogingsfactor (F)	0,9
Licht Efficiëntie (LE)	70,4 lux/W	Energie-efficiëntie Index	52,0
Licht Efficiëntieklasse (LEC)	A	Gemeten luchtdebiet op het beste efficiëntiepunt (Qbep)	395 m ³ /h
Vetfilter Efficiëntie (GFE)	79,7 %	Gemeten luchtdruk op het beste efficiëntiepunt (Pbep)	451 Pa
Vetfilter Efficiëntieklasse (GFEC)	C	Gemeten elektrisch vermogen op het beste efficiëntiepunt (Wbep)	159 W
Debiet luchtafvoer op minimum snelheid (Qmin)	261 m ³ /h	Nominaal energieverbruik van de verlichting (WL)	3 W
Luchtstroom bij maximale snelheid (Qmax)	473 m ³ /h	Gemiddelde verlichting op het kookoppervlak (Emiddle)	156 lux
Luchtstroom bij intensieve snelheid (Qboost)	686 m ³ /h	Geluidsniveau bij de hoogste instelling (Lwa)	71 dBA

Elektrische aansluiting

Lengte voedingskabel 1500 mm

Nominale aansluitwaarde	230 W	Stekker	Nee
Spanning	220-240 V		
Frequentie	50-60 Hz		

Opties niet inbegrepen

Koolstoffilter	No	Schouw dampkap	No
Afstandsbediening inbegrepen	No	Ventilatie outlet	No

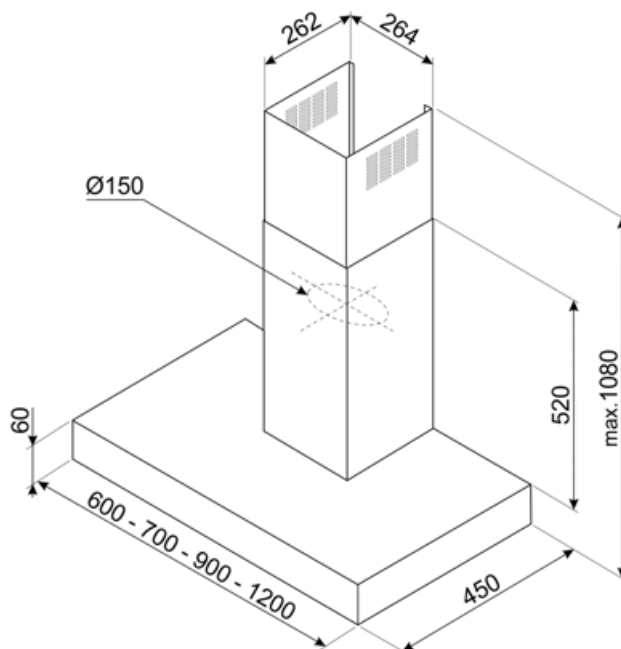

Compatible Accessories



KITCEKBTMB



KITFCKBT







1 pc of charcoal filter for the hood models KBT* / KBCT*



KITFCKBTR

1 pcs of Charcoal filter Regenerable* suitable for all the KBT/KBCT models. * It can be washed in the dishwasher up to 12 times and dry in the oven at max 90° for 60 min. dimension 237,5(H)x245x10 mm

Symbols glossary

- | | | | |
|--|---|---|---|
|  | 24h: When selected this function refreshes the air for c. 10 minutes every hour over a 24 hour period, at minimum speed and an imperceptible noise level. |  | Energy efficiency class A |
|  | Filters: Model has filters to help remove grease from the steam emanating from the pans during cooking. |  | Automatisch uitschakelen: Een speciale instelling, om na het einde van de bereiding een vooraf ingestelde tijd te laten lopen en daarna automatisch uit te schakelen. |
|  | Warning light(s): to advise when filters need changing. |  | Lights: All cooker hoods feature lights to illuminate the cooking area or add to the ambience of the kitchen. |
|  | Intensive/turbo setting: when extra fast extraction is required. | | |