

KBT900VE

Product family	Hood
Hood Type	Decorative wall hood
Design	T flat
Extraction	Extraction
Electronic control	Yes
Material	Stainless Steel + Glass
Type of steel	Brushed
EAN code	8017709289706
Hood width	90 cm
Aesthetic	Universale
Colour	Stainless steel
Finishing	Satin
Logo	Silk screen



Controls

Control setting	Electronic buttons
-----------------	--------------------

Program / Functions

No. of speeds	3
Intensive speed	
24h air filter function	
Time-setting options	

Technical Features



No. of lights	2	Anti-grease filters	Aluminium
Light type	LED	Filter replacement indicator	Yes
Light Power	1,3 W	Vent outlet	150 mm
Light color temperature scale (K)	3000 K	Minimum distance from GAS hob	650 mm
Free outlet maximum capacity	730 m ³ /h	Minimum distance from ELECTRIC hob	500 mm
Motor power	230 W	Non return valve	Yes
No. of filters	1		

	Extraction rate IEC 61591 [m ³ /h]	Noise level IEC 60704-2-13 [dBA]
Speed 1	243	48
Speed 2	332	55
Speed 3	451	62
Intensive speed	677	71

Accessories included

Tube reduction Yes

Performance / Energy Label



Annual Efficiency Consumption (AEChood)	60 kWh/a	Airbourne acoustical A-weighted sound Power Emission at minimum speed (SPEmin)	47 dBA
Energy efficiency class (EEC)	B	Airborne acoustical A-weighted sound Power Emission at maximum speed (SPEmax)	62 dBA
Fluid Dynamic Efficiency (FDE)	29,1	Airbourne acoustical A-weighted sound power emission at boost speed (SPEboost)	70 dBA
Fluid Dynamic Efficiency class (FDEC)	A	Time increase factor (F)	1,0
Lighting Efficiency (LE)	71,0 lux/W	Energy Efficiency Index	59,5
Lighting Efficiency Class (LEC)	A	Measured air flow rate at best efficiency point (Qbep)	383 m ³ /h
Grease Filtering Efficiency (GFE)	81,1 %	Measured air pressure at best efficiency point (Pbep)	433 Pa
Grease Filtering Efficiency Class (GFEC)	C	Measured electric power input at best efficiency point (Wbep)	158 W
Air flow at minumum speed (Qmin)	243 m ³ /h	Nominal Power consumption of the light system (WL)	3 W
Air flow at maximum speed (Qmax)	451 m ³ /h	Average illumination of the light on the cooking surface (Emiddle)	186 lux
Air flow at boost speed (Qboost)	677 m ³ /h	Sound power level at highest setting (Lwa)	62 dBA

Electrical Connection

Electrical connection rating	233 W	Power supply cable length	1500 mm
Voltage	220-240 V	Plug	Not present
Frequency (Hz)	50-60 Hz		

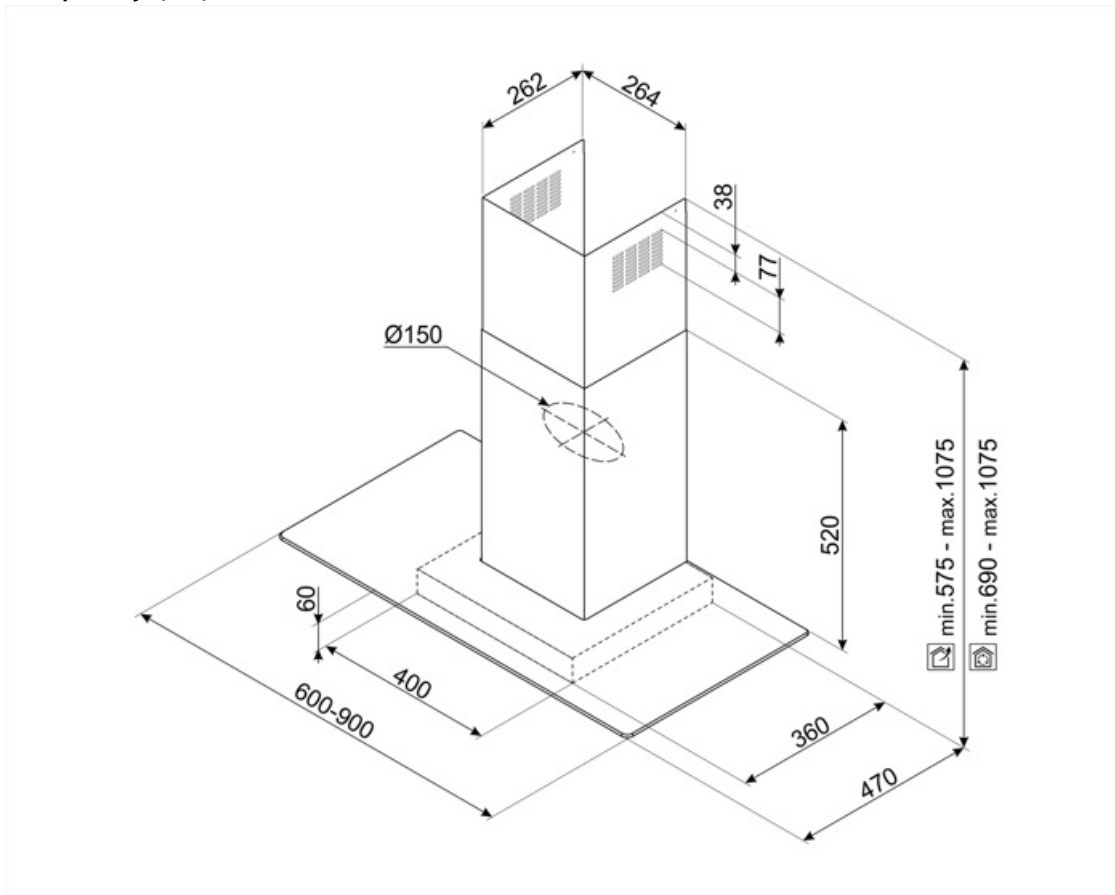

Compatible Accessories



KITCEKBT

Chimney extension, dimensions 261,5 * 260 * 830 mm suitable for T-shape hood KBT* & KBCT*, max height 1380 mm Stainless Steel



KITFCKBT







1 pc of charcoal filter for the hood models KBT* / KBCT*



KITFCKBTR

1 pcs of Charcoal filter Regenerable* suitable for all the KBT/KBCT models. * It can be washed in the dishwasher up to 12 times and dry in the oven at max 90° for 60 min. dimension 237,5(H)x245x10 mm

Symbols glossary

- | | | | |
|--|---|---|---|
|  | 24h: When selected this function refreshes the air for c. 10 minutes every hour over a 24 hour period, at minimum speed and an imperceptible noise level. |  | Filters: Model has filters to help remove grease from the steam emanating from the pans during cooking. |
|  | Switch off automatically: A special setting, to run after the end of cooking for a pre-set time and then switch off automatically. |  | Warning light(s): to advise when filters need changing. |
|  | Lights: All cooker hoods feature lights to illuminate the cooking area or add to the ambience of the kitchen. |  | Intensive/turbo setting: when extra fast extraction is required. |
|  | | | |