

KCV9NE2



Product family	Hood
Tipo de Exaustor	Decorative wall hood
Design	Angled
Extraction	Extraction
Electronic control	Yes
Perimeter extraction	Yes
Material	Glass
Type of steel	Brushed
EAN code	8017709257194
Aesthetic	Linea
Colour	Black
Acabamento	Glass
Glass Type	Black
Cor da serigrafia	Serigrafia em cinzento
Logotipo	Logotipo embutido





Controls



Control setting	Touch control	Display	Yes
Led color	Ice		

Program / Functions

No. of speeds	3
Intensive speed	
24h air filter function	
Other functions	No
Time-setting options	
Other options	No
Ventilação automática	No

Technical Features



Hood without motor	No	No. of filters	1
Remote motor	No	Anti-grease filters	Stainless steel
No. of lights	2	Charcoal filters included	No
Light type	LED	Filter replacement indicator	Yes
Light Power	1 W		

Dimmer mode	Yes	Vent outlet	150 mm
Escala de temperatura de cor clara (°K)	4000 °K	Minimum distance from GAS hob	467 mm
Free outlet maximum capacity	815 m ³ /h	Minimum distance from ELECTRIC hob	467 mm
Motor power	275 W	Non return valve	Yes

	Extraction rate IEC 61591 [m ³ /h]	Noise level IEC 60704-2-13 [dBA]
Speed 1	218	42
Speed 2	322	63
Speed 3	600	65
Intensive speed	734	70

Accessories Included

Remote control	No	Tube reduction	No
Sliding door	No		

Performance / Energy Label



Consumo anual de energia (CAE exaustor)	60 kWh/a	Airborne acoustical A-weighted sound Power Emission at maximum speed (SPEmax)	65 dBA
Energy efficiency class (EEC)	B	Airbourne acoustical A-weighted sound power emission at boost speed (SPEboost)	72 dBA
Fluid Dynamic Efficiency (FDE)	28,6	Power Consumption in Off mode (Po)	0,49 W
Fluid Dynamic Efficiency class (FDEC)	A	Time increase factor (F)	1
Lighting Efficiency (LE)	99,1 lux/W	Energy Efficiency Index	57,4
Lighting Efficiency Class (LEC)	A	Measured air flow rate at best efficiency point (Qbep)	384 m ³ /h
Grease Filtering Efficiency (GFE)	42,2 %	Measured air pressure at best efficiency point (Pbep)	428 Pa
Grease Filtering Efficiency Class (GFEC)	G	Measured electric power input at best efficiency point (Wbep)	160 W
Air flow at minumum speed (Qmin)	218 m ³ /h	Nominal Power consumption of the light system (WL)	2 W
Air flow at maximum speed (Qmax)	600 m ³ /h	Average illumination of the light on the cooking surface (Emiddle)	218 lux
Air flow at boost speed (Qboost)	734 m ³ /h		
Airbourne acoustical A-weighted sound Power Emission at minimum speed (SPEmin)	42 dBA		

Sound power level at highest setting (Lwa) 65 dBA

Electrical Connection

Plug	No	Frequency (Hz)	50-60 Hz
Electrical connection rating	278 W	Comprimento do cabo de alimentação	1000 mm
Voltage	220-240 V		

Also available

Outras cores disponíveis Branca, Vidro Silver

Códigos das outras cores disponíveis

KCV9BE2 - KCV9SE2

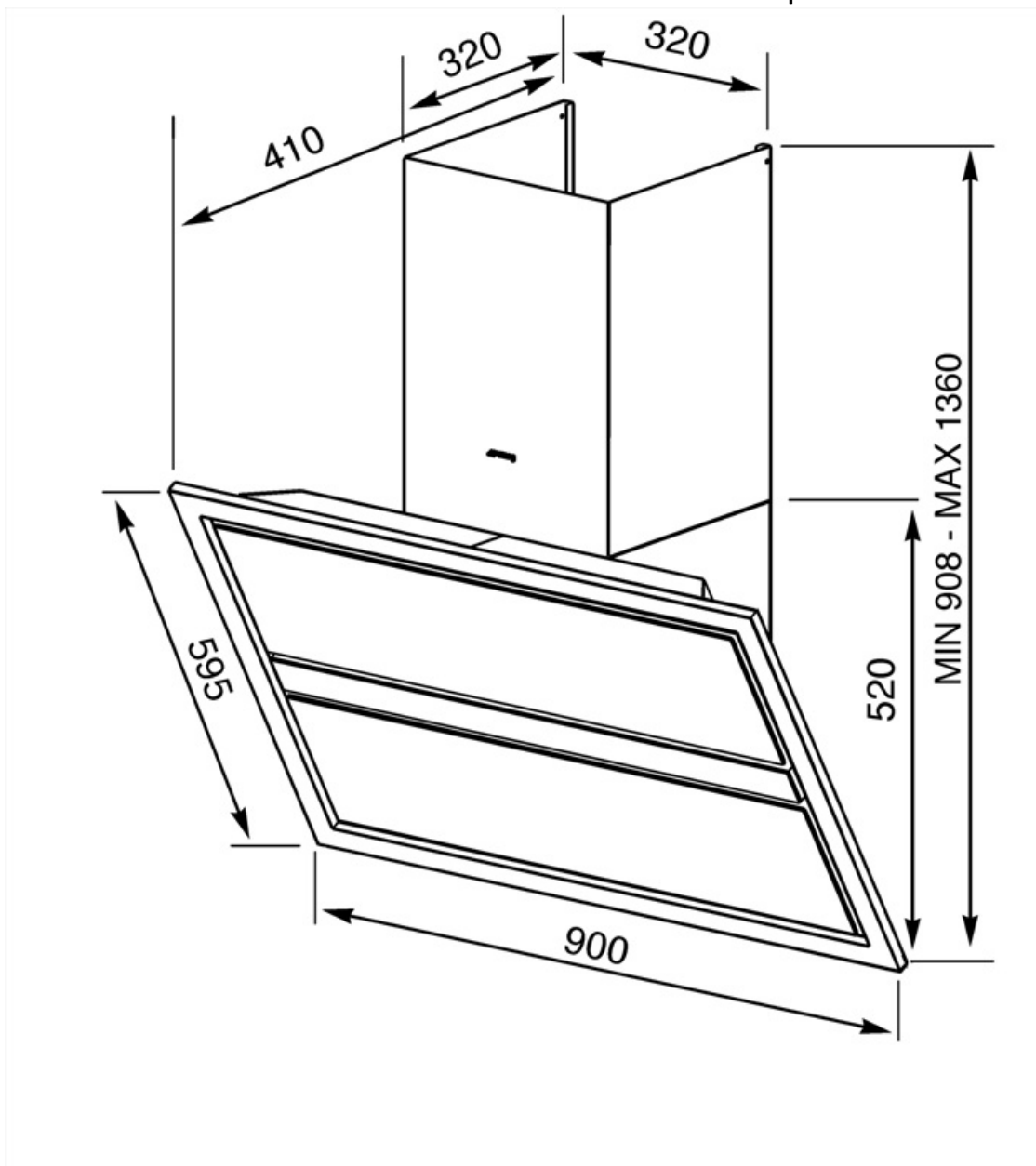

Compatible Accessories



KITALLFC

Filtro de carvão universal Aço inoxidável AISI 304 O filtro pode ser lavado na máquina lava-louça a 50 °C (água e detergente adequado) e para secar colocar no forno 180°C 25 minutos

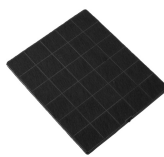

KITFC906



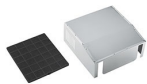







Kit filtro de carvão 1 peça



KITFTS

Caixa de aço inoxidável + Kit filtro de carvão 1 peça

Symbols glossary

	24h: Quando selecionada, esta função refresca o ar durante cerca de 10 minutos a cada hora durante um período de 24 horas, a uma velocidade mínima e a um nível de ruído imperceptível.		Filtros: O modelo tem filtros para ajudar a remover a graxa do vapor que emana das panelas durante o cozimento.
	Desligar automaticamente: Uma configuração especial, para ser executada após o final do cozimento por um tempo pré-definido e, em seguida, desligar automaticamente.		
	Luzes de escurecimento		Display LED: para mostrar os programas, funções e opções selecionadas e o tempo até ao final do ciclo.
	Luz(s) de aviso: para avisar quando os filtros precisam ser trocados.		Luzes: Todos os exaustores possuem luzes para iluminar a área de cozinhar ou adicionar ao ambiente da cozinha.
	Painéis de extração de perímetro: muito eficiente e ajuda na redução de ruído.		Controles táteis: O controles táteis, fáceis de usar, permitem que o aparelho seja programado com o toque de um botão.
	Configuração intensiva/turbo: quando a extração extra rápida é necessária.		

Benefit (TT)

Dimmering & Tunable lights

Customized lighting with LED lights featuring adjustable intensity and color temperature, from warm to cool tones

Perimetral aspiration

Optimized extraction through the perimeter aspiration system

Perimeter aspiration enhances extraction efficiency by directing vapors along the edges of the panel beneath the filters, optimizing air capture