

# KDD90CNE



Product family	Hood
Hood Type	DownDraft
Design	Fully integrated
Extraction	Extraction
Electronic control	Yes
Perimeter extraction	Yes
Material	Glass
Type of steel	Brushed
EAN code	8017709305796
Hood width	90 cm
Aesthetic	Universale
Colour	Black
Finishing	Glass
Glass Type	Black
Serigraphy colour	Silver
Logo	Silk screen





## Controls



Control setting	Touch control	Display	Digital
Led color	White		

## Program / Functions

No. of speeds	4
Intensive speed	
24h air filter function	
Time-setting options	

## Technical Features



Remote motor	KITRBDD - Kit Optional	Free outlet maximum capacity	725 m <sup>3</sup> /h
No. of lights	1	Motor power	270 W
Light type	LED	No. of filters	2
Light Power	7 W	Anti-grease filters	Aluminium
Dimmer mode	Yes	Filter replacement indicator	Yes
Light color temperature scale (K)	4000 K		

Vent outlet

150 mm

	Extraction rate IEC 61591 [m <sup>3</sup> /h]	Noise level IEC 60704-2-13 [dBA]
Speed 1	160	40
Speed 2	290	53
Speed 3	350	54
Speed 4	430	60
Intensive speed	700	70

## Accessories included

Motorised opening	Yes	Tube reduction	Yes
-------------------	-----	----------------	-----

## Performance / Energy Label



Annual Efficiency Consumption (AEC <sub>hood</sub> )	58 kWh/a	Airbourne acoustical A-weighted sound Power Emission at minimum speed (SPE <sub>min</sub> )	40 dBA
Energy efficiency class (EEC)	A	Airborne acoustical A-weighted sound Power Emission at maximum speed (SPE <sub>max</sub> )	54 dBA
Fluid Dynamic Efficiency (FDE)	30	Airbourne acoustical A-weighted sound power emission at boost speed (SPE <sub>boost</sub> )	70 dBA
Fluid Dynamic Efficiency class (FDEC)	A	Time increase factor (F)	0.9
Lighting Efficiency (LE)	29 lux/W	Energy Efficiency Index	53.8
Lighting Efficiency Class (LEC)	A	Measured air flow rate at best efficiency point (Q <sub>bep</sub> )	397 m <sup>3</sup> /h
Grease Filtering Efficiency (GFE)	65.1 %	Measured air pressure at best efficiency point (P <sub>bep</sub> )	441 Pa
Grease Filtering Efficiency Class (GFEC)	D	Measured electric power input at best efficiency point (W <sub>bep</sub> )	162 W
Air flow at minumum speed (Q <sub>min</sub> )	160 m <sup>3</sup> /h	Nominal Power consumption of the light system (WL)	7 W
Air flow at maximum speed (Q <sub>max</sub> )	350 m <sup>3</sup> /h	Average illumination of the light on the cooking surface (E <sub>middle</sub> )	200 lux
Air flow at boost speed (Q <sub>boost</sub> )	700 m <sup>3</sup> /h	Sound power level at highest setting (L <sub>wa</sub> )	54 dBA

## Electrical Connection

Electrical connection rating	277 W	Power supply cable length	1500 mm
Voltage	220-240 V	Plug	(F;E) Schuko
Frequency (Hz)	50-60 Hz		

## Also available

Alternative colours available	White, Silver Glass	Available colours	KDD90VXBE - KDD90VXSE
-------------------------------	---------------------	-------------------	-----------------------

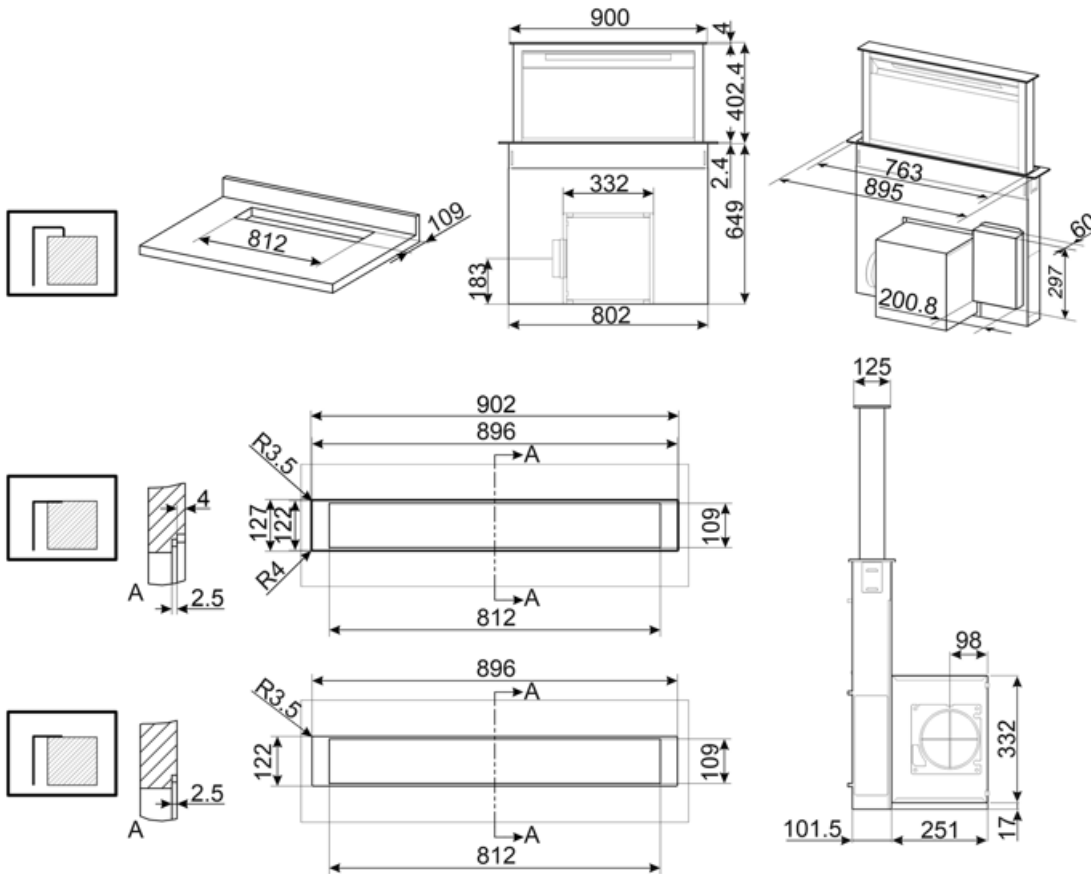

---

## Compatible Accessories

---



### KITFCDD

Charcoal filter for hood Down Draft Kit 2 pieces. Dishwasher safe













### RCKF2

Remote control

### KITRBDD

kit remote blower for DD hood. Cable length: 7 meters.

## Symbols glossary

- |   |   |   |  |
|---|---|---|--|
|   | 24h: When selected this function refreshes the air for c. 10 minutes every hour over a 24 hour period, at minimum speed and an imperceptible noise level. |  | Energy efficiency class A  |
|   | Filters: Model has filters to help remove grease from the steam emanating from the pans during cooking.   |  | Switch off automatically: A special setting, to run after the end of cooking for a pre-set time and then switch off automatically. |
|   | Electronic display: to give a visual reminder of the options selected.  |  | Warning light(s): to advise when filters need changing.  |
|   | Lights: All cooker hoods feature lights to illuminate the cooking area or add to the ambience of the kitchen.   |  | Perimeter extraction panels: very efficient and aid noise reduction.   |
|   | Touch controls: Easy to use touch controls allow the appliance to be programmed at the touch of a button.   |  | Intensive/turbo setting: when extra fast extraction is required.   |
|  | Dimmering Lights  |   |  |