

KDH12WLD



Product family	Hood
Hood Type	DownDraft
Design	Fully integrated
Extraction	Extraction
Electronic control	Yes
Perimeter extraction	Yes
Material	Glass
EAN code	8017709277826
Hood width	12 cm
Aesthetic	Universale
Colour	Black
Finishing	Glass
Glass Type	ceramic Eclipse
Serigraphy colour	White
Logo	Silk screen



Controls



Control setting	Touch control	Display	Digital
Led color	Ice		

Program / Functions

No. of speeds	3
Intensive speed	
Time-setting options	

Technical Features



Free outlet maximum capacity	570 m ³ /h	Anti-grease filters	Stainless steel
Motor power	145 W	Filter replacement indicator	Yes
No. of filters	1		

	Extraction rate IEC 61591 [m ³ /h]	Noise level IEC 60704-2-13 [dBA]
Speed 1	370	62
Speed 2	420	66

Speed 3	470	69
Intensive speed	550	72

Accessories included

Motorised opening Yes

Performance / Energy Label



Annual Efficiency Consumption (AEChood)	37 kWh/a	Airbourne acouistical A-weighted sound Power Emission at minimum speed (SPEmin)	62 dBA
Energy efficiency class (EEC)	A+	Airborne acoustical A-weighted sound Power Emission at maximum speed (SPEmax)	69 dBA
Fluid Dynamic Efficiency (FDE)	32	Airbourne acouistical A-weighted sound power emission at boost speed (SPEboost)	72 dBA
Fluid Dynamic Efficiency class (FDEC)	A	Time increase factor (F)	0.8
Lighting Efficiency Class (LEC)	NA	Energy Efficiency Index	43.4
Grease Filtering Efficiency (GFE)	75.1 %	Measured air flow rate at best efficiency point (Qbep)	295 m ³ /h
Grease Filtering Efficiency Class (GFEC)	C	Measured air pressure at best efficiency point (Pbep)	490 Pa
Air flow at minumum speed (Qmin)	370 m ³ /h	Measured electric power input at best efficiency point (Wbep)	125 W
Air flow at maximum speed (Qmax)	470 m ³ /h	Sound power level at highest setting (Lwa)	72 dBA
Air flow at boost speed (Qboost)	550 m ³ /h		

Electrical Connection

Electrical connection rating	145 W	Frequency (Hz)	50-60 Hz
Voltage	220-240 V	Power supply cable length	1500 mm

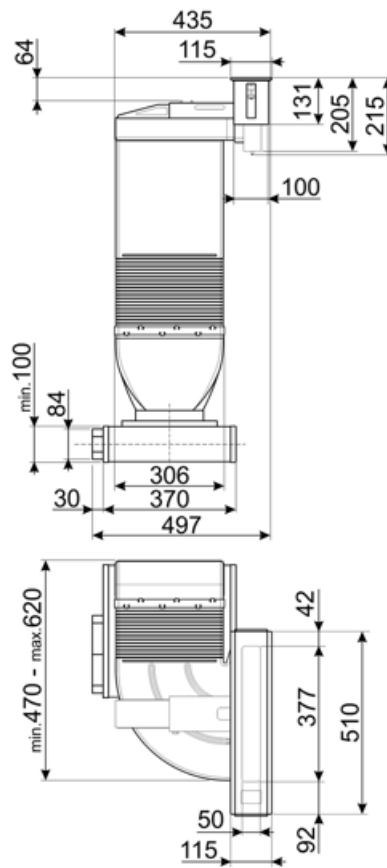

Compatible Accessories



CFKDH12HP

Ceramic filter for Domino Hood KDH12WLD Kit 1 piece High performances. Regenerable into oven
Magnetic Metallic grid included.



FLMSTPKDH12

Metallic flame guard hob aspiration hood Kit 1 piece

GRIDKDH12

Metallic grid for standard charcoal filter hob aspiration hood Kit 1 piece



CFKDH12STD



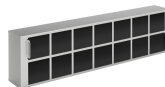





Charcoal filter for hob aspiration hood Kit 1 piece



FLTKDH

Anti-Odour Filter Ceramic regenerative suitable for Recirculating kit (accessory CFKDH12HP)

Symbols glossary

- | | | | |
|--|--|---|---|
|  | A+: Energy efficiency class A+ helps to save up to 10% energy compared to class A. Maximum performance with minimum consumption is guaranteed. |  | Filters: Model has filters to help remove grease from the steam emanating from the pans during cooking. |
|  | Switch off automatically: A special setting, to run after the end of cooking for a pre-set time and then switch off automatically. |  | Electronic display: to give a visual reminder of the options selected. |
|  | Warning light(s): to advise when filters need changing. |  | Perimeter extraction panels: very efficient and aid noise reduction. |
|  | Touch controls: Easy to use touch controls allow the appliance to be programmed at the touch of a button. |  | Intensive/turbo setting: when extra fast extraction is required. |