

KICGR70X



Product familie	Dampkap
Type dampkap	Inbouwdampkap
Type dampkap	Volledig integreerbaar
Extractie	Extractie
Elektronische bediening	Ja
Randafzuiging	Ja
Materiaal	Inox
Type staal	Geborsteld inox
EAN-code	8017709262204
Breedte dampkap	70 cm



Design





Design	Universeel	Afwerking	Geborsteld inox
Kleur	Inox	Logo	Geëtst

Bediening



Bediening	Elektronische toetsen	Display	1 LED
LED kleur	Rood		

Programma's / Functies

Aantal snelheden	3
Snelheid Intensief	
Luchtzuiveringsfunctie (24 uur)	
Automatische uitschakeling	
Auto-Vent	

Technische specificaties



Aantal lampen	2	Vetfilters	Aluminium
---------------	---	------------	-----------

Type lamp	LED	Indicator vervangen filter	Ja
Vermogen lamp	1 W	Diameter ventilatie outlet	150 mm
Capaciteit P0	720 m ³ /h	Minimum afstand van gaskookplaat	650 mm
Vermogen motor	270 W	Minimum afstand van elektrische kookplaat	550 mm
Aantal filters	1		

	Capaciteit niveau 1 (IEC 61591) [m ³ /h]	Geluidsniveau niveau 1 (IEC 60704-2-13) [dB(A)]
Snelheid 1	300	57
Snelheid 2	420	62
Snelheid 3	590	69
Snelheid Intensief	690	72

Meegeleverde accessoires

Reductie pijp	Ja
---------------	----

Prestaties / energielabel

A	
Jaarlijkse energieconsumptie (AEC)	54 KWh/jaar
Energie-efficiëntieklasse (EEC)	A
Hydrodynamische efficiëntieklasse (FDE)	29,2
Hydrodynamische efficiëntieklasse (FDEC)	A
Licht Efficiëntie (LE)	91 lux/W
Licht Efficiëntieklasse (LEC)	A
Vetfilter Efficiëntie (GFE)	75,1 %
Vetfilter Efficiëntieklasse (GFEC)	C
Debiet luchtafvoer op minimum snelheid (Qmin)	300 m ³ /h
Luchtstroom bij maximale snelheid (Qmax)	590 m ³ /h
Akoestische A-gewogen geluidsemissie op maximum snelheid	69 dB(A)
Akoestische A-gewogen geluidsvermogens in de lucht met intensieve snelheid	72 dB(A)
Vermogensverbruik in Off modus (Po)	0,49 W
Tijdverhogingsfactor (F)	0,9
Energie-efficiëntie Index	51,7
Gemeten luchtdebiet op het beste efficiëntiepunt (Qbep)	398 m ³ /h
Gemeten luchtdruk op het beste efficiëntiepunt (Pbep)	417 Pa
Gemeten elektrisch vermogen op het beste efficiëntiepunt (Wbep)	158 W
Nominaal energieverbruik van de verlichting (WL)	2 W

Luchtstroom bij
intensieve snelheid
(Qboost) 690 m³/h

Akoestische geluidsdruk
op minimum snelheid
(SPEmin) 56 dB(A)

Gemiddelde verlichting
op het kookoppervlak
(Emiddle) 200 lux

Geluidsniveau bij de
hoogste instelling (Lwa) 69 dB(A)

Elektrische aansluiting

Nominale
aansluitwaarde 272 W
Spanning 220-240 V

Frequentie 50-60 Hz
Lengte voedingskabel 1500 mm

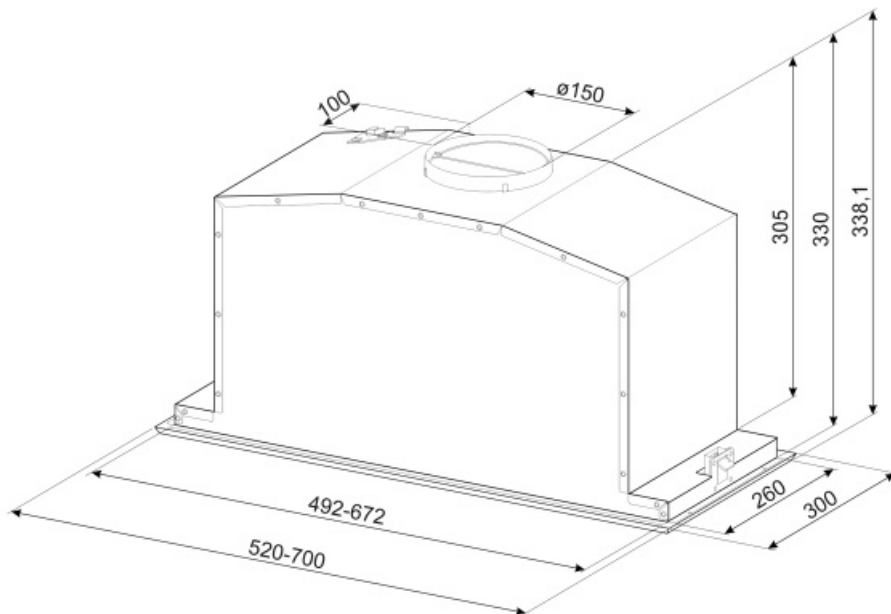

Not included accessories



KITFC152











Charcoal filters Round Kit 2 pieces



KITVENT150

Imbocco motore 150 mm con valvola di non ritorno

Symbols glossary (TT)

- | | | | |
|--|---|---|---|
|  | 24h: When selected this function refreshes the air for c. 10 minutes every hour over a 24 hour period, at minimum speed and an imperceptible noise level. |  | Filters: Model has filters to help remove grease from the steam emanating from the pans during cooking. |
|  | A smart infrared system, which allows a hood and hob with this feature to work together. |  | Automatisch uitschakelen: Een speciale instelling, om na het einde van de bereiding een vooraf ingestelde tijd te laten lopen en daarna automatisch uit te schakelen. |
|  | LED display: to show programmes, functions and options selected and the time to the end of the cycle. |  | A: Product drying performance, measured from A+++ to D / G depending on the product family |
|  | Warning light(s): to advise when filters need changing. |  | Lights: All cooker hoods feature lights to illuminate the cooking area or add to the ambience of the kitchen. |
|  | Perimeter extraction panels: very efficient and aid noise reduction. |  | Intensive/turbo setting: when extra fast extraction is required. |