

KLT12L4X

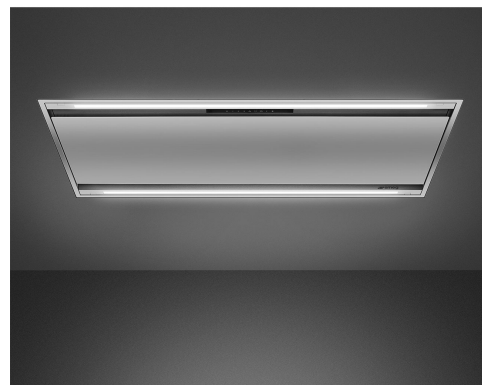





Product familie	Dampkap
Type dampkap	Plafond dampkap
Type dampkap	Plafond dampkap
Extractie	Extractie
Elektronische bediening	Ja
Randafzuiging	Ja
Materiaal	Inox
Type staal	Geborsteld inox
EAN-code	8017709326203
Breedte dampkap	120 cm
Design	Universeel
Kleur	Inox
Afwerking	Geborsteld inox
Logo	Geëtst



Bediening

Bediening	Touch bediening met witte LED
-----------	-------------------------------

Program / Functions

Aantal snelheden	3
Snelheid Intensief	
Luchtzuiveringsfunctie (24 uur)	
Automatische uitschakeling	
Auto-Vent 2.0	

Technische specificaties



Aantal lampen	2	Aantal filters	4
Type lamp	LED	Vetfilters	Aluminium
Vermogen lamp	7.4 W	Indicator vervangen filter	Ja
Dimmerfunctie	Ja	Diameter ventilatie outlet	150 mm
Temperatuur licht aanpasbaar	3000 - 5700 K	Minimum afstand van gaskookplaat	650 mm
Capaciteit P0	610 m ³ /h	Minimum afstand van elektrische kookplaat	650 mm
Vermogen motor	270 W		

Terugslagklep

Ja

	Capaciteit niveau 1 (IEC 61591) [m ³ /h]	Geluidsniveau niveau 1 (IEC 60704-2-13) [dBA]
Snelheid 1	194	51
Snelheid 2	315	57
Snelheid 3	447	65
Snelheid Intensief	591	71

Meegeleverde accessoires

Afstandsbediening inbegrepen Ja

Prestaties / energielabel



Jaarlijkse energieconsumptie (AEC)	91 kWh/jaar	Akoestische geluidsdruk op minimum snelheid (SPEmin)	51 dBA
Energie-efficiëntieklasse (EEC)	B	Akoestische A-gewogen geluidsemissie op maximum snelheid	66 dBA
Hydrodynamische efficiëntieklasse (FDE)	27.1	Akoestische A-gewogen geluidsvermogens in de lucht met intensieve snelheid	71 dBA
Hydrodynamische efficiëntieklasse (FDEC)	B	Tijdverhogingsfactor (F)	1.0
Licht Efficiëntie (LE)	20.1 lux/W	Energie-efficiëntie Index	63.0
Licht Efficiëntieklasse (LEC)	B	Gemeten luchtdebiet op het beste efficiëntiepunt (Qbep)	339.3 m ³ /h
Vetfilter Efficiëntie (GFE)	62.7 %	Gemeten luchtdruk op het beste efficiëntiepunt (Pbep)	632 Pa
Vetfilter Efficiëntieklasse (GFEC)	E	Gemeten elektrisch vermogen op het beste efficiëntiepunt (Wbep)	219.5 W
Debiet luchtafvoer op minimum snelheid (Qmin)	194 m ³ /h	Nominaal energieverbruik van de verlichting (WL)	14.8 W
Luchtstroom bij maximale snelheid (Qmax)	447 m ³ /h	Gemiddelde verlichting op het kookoppervlak (Emiddle)	298 lux
Luchtstroom bij intensieve snelheid (Qboost)	591 m ³ /h	Geluidsniveau bij de hoogste instelling (Lwa)	66 dBA

Elektrische aansluiting

Nominale aansluitwaarde 305 W
Spanning 220-240 V
Frequentie 50-60 Hz

Lengte voedingskabel 1500 mm
Stekker Nee

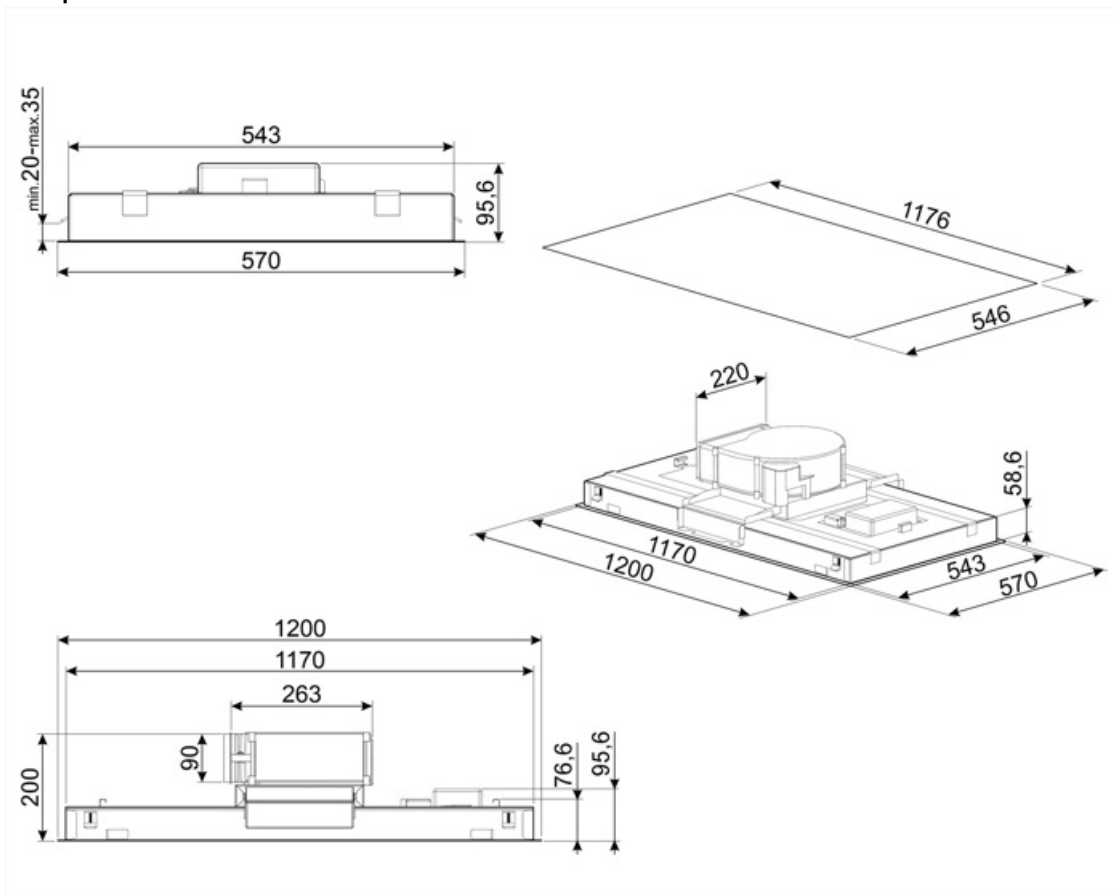

Compatible Accessories



KITALLFC

Universal Charcoal filter Stainless Steel AISI 304 The filter can be washed in dishwasher 50 °C (water and suitable detergent) and to dry it put in the oven 180°C 25 minutes



KITFCKLTR











1 pcs of Charcoal filter Regenerable* suitable for all the KLT* models. * It can be washed in the dishwasher up to 12 times and dry in the oven at max 90° for 60 min. dimension 235(H)x 200 (L) x 10 (D) mm



RRA90

Round to rectangular adapter 220x90 mm to 150 Ø

Symbols glossary

	24h: When selected this function refreshes the air for c. 10 minutes every hour over a 24 hour period, at minimum speed and an imperceptible noise level.		Filters: Model has filters to help remove grease from the steam emanating from the pans during cooking.
	Automatisch uitschakelen: Een speciale instelling, om na het einde van de bereiding een vooraf ingestelde tijd te laten lopen en daarna automatisch uit te schakelen.		Warning light(s): to advise when filters need changing.
	Lights: All cooker hoods feature lights to illuminate the cooking area or add to the ambience of the kitchen.		Perimeter extraction panels: very efficient and aid noise reduction.
	Intensive/turbo setting: when extra fast extraction is required.		Connection between hob and hood
	Dimming Lights		Tunable white from warm to cold.
