

# KLT9L4WH







Product familie	Dampkap
Type dampkap	Plafond dampkap
Type dampkap	Plafond dampkap
Extractie	Extractie
Elektronische bediening	Ja
Randafzuiging	Ja
Materiaal	Inox
Type staal	Geborsteld inox
EAN-code	8017709326210
Breedte dampkap	90 cm
Design	Universeel
Kleur	Matt White
Afwerking	Geborsteld inox
Logo	Geëtst



## Bediening

Bediening	Touch bediening met witte LED
-----------	-------------------------------

## Program / Functions

Aantal snelheden	3
Snelheid Intensief	
Luchtzuiveringsfunctie (24 uur)	
Automatische uitschakeling	
Auto-Vent 2.0	

## Technische specificaties



Aantal lampen	2	Aantal filters	3
Type lamp	LED	Vetfilters	Aluminium
Vermogen lamp	7.4 W	Indicator vervangen filter	Ja
Temperatuur licht (Kelvin)	3000 K	Diameter ventilatie outlet	150 mm
Temperatuur licht aanpasbaar	3000 - 5700 K	Minimum afstand van gaskookplaat	650 mm
Capaciteit P0	610 m <sup>3</sup> /h	Minimum afstand van elektrische kookplaat	650 mm
Vermogen motor	270 W		

Terugslagklep

Ja

	Capaciteit niveau 1 (IEC 61591) [m <sup>3</sup> /h]	Geluidsniveau niveau 1 (IEC 60704-2-13) [dBA]
Snelheid 1	208	48
Snelheid 2	323	55
Snelheid 3	452	62
Snelheid Intensief	594	69

## Meegeleverde accessoires

Afstandsbediening inbegrepen Ja

## Prestaties / energielabel



Jaarlijkse energieconsumptie (AEC)	94 kWh/jaar	Akoestische geluidsdruk op minimum snelheid (SPEmin)	48 dBA
Energie-efficiëntieklasse (EEC)	B	Akoestische A-gewogen geluidsemisatie op maximum snelheid	63 dBA
Hydrodynamische efficiëntieklasse (FDE)	25.9	Akoestische A-gewogen geluidsvermogens in de lucht met intensieve snelheid	69 dBA
Hydrodynamische efficiëntieklasse (FDEC)	B	Tijdverhogingsfactor (F)	1.1
Licht Efficiëntie (LE)	25.9 lux/W	Energie-efficiëntie Index	68.7
Licht Efficiëntieklasse (LEC)	B	Gemeten luchtdebiet op het beste efficiëntiepunt (Qbep)	335 m <sup>3</sup> /h
Vetfilter Efficiëntie (GFE)	72.0 %	Gemeten luchtdruk op het beste efficiëntiepunt (Pbep)	630 Pa
Vetfilter Efficiëntieklasse (GFEC)	D	Gemeten elektrisch vermogen op het beste efficiëntiepunt (Wbep)	226 W
Debiet luchtafvoer op minimum snelheid (Qmin)	208 m <sup>3</sup> /h	Nominaal energieverbruik van de verlichting (WL)	15 W
Luchtstroom bij maximale snelheid (Qmax)	452 m <sup>3</sup> /h	Gemiddelde verlichting op het kookoppervlak (Emiddle)	303 lux
Luchtstroom bij intensieve snelheid (Qboost)	594 m <sup>3</sup> /h	Geluidsniveau bij de hoogste instelling (Lwa)	63 dBA

## Elektrische aansluiting

Nominale aansluitwaarde	305 W	Lengte voedingskabel	1500 mm
Spanning	220-240 V	Stekker	Nee
Frequentie	50-60 Hz		

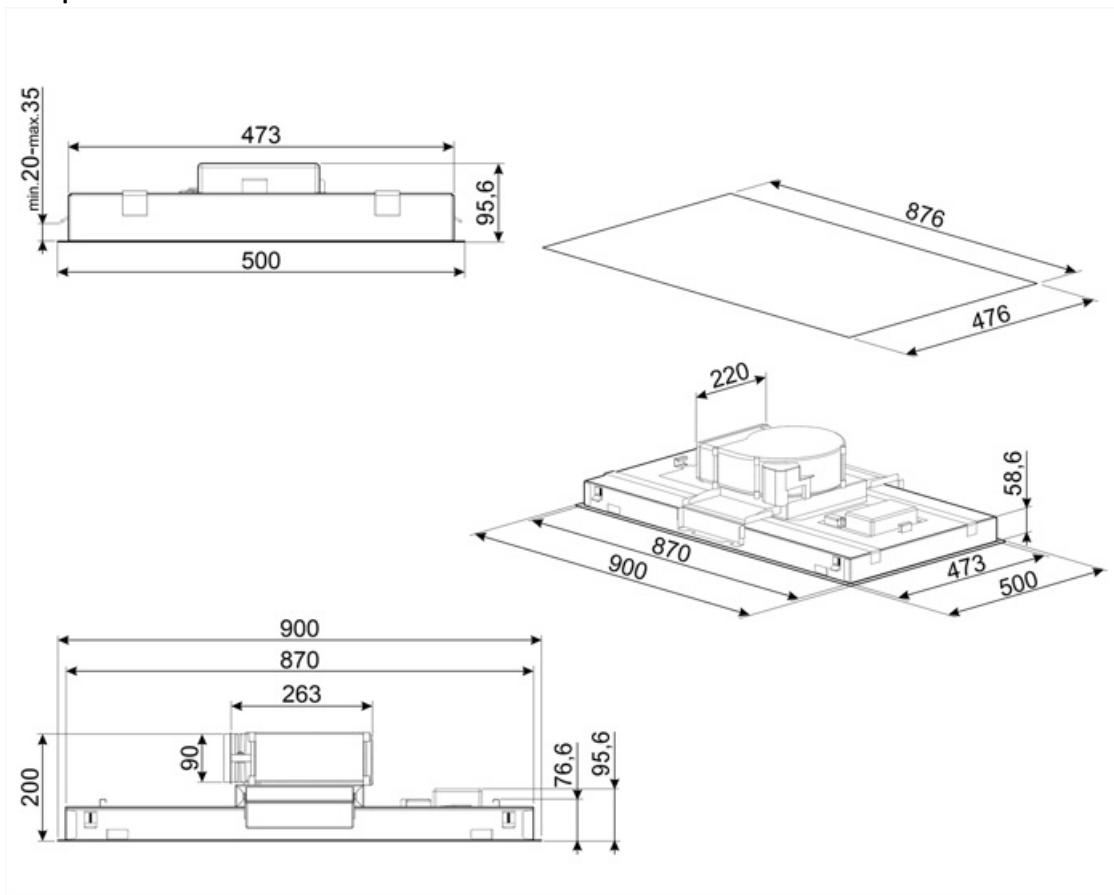

---

## Compatible Accessories

---



### KITALLFC

Universal Charcoal filter Stainless Steel AISI 304 The filter can be washed in dishwasher 50 °C (water and suitable detergent) and to dry it put in the oven 180°C 25 minutes



### KITFCKLTR











1 pcs of Charcoal filter Regenerable\* suitable for all the KLT\* models. \* It can be washed in the dishwasher up to 12 times and dry in the oven at max 90° for 60 min. dimension 235(H)x 200 (L) x 10 (D) mm



### RRA90

Round to rectangular adapter 220x90 mm to 150 Ø

## Symbols glossary

	24h: When selected this function refreshes the air for c. 10 minutes every hour over a 24 hour period, at minimum speed and an imperceptible noise level.		Filters: Model has filters to help remove grease from the steam emanating from the pans during cooking.
	Connection between hob and hood		Automatisch uitschakelen: Een speciale instelling, om na het einde van de bereiding een vooraf ingestelde tijd te laten lopen en daarna automatisch uit te schakelen.
			Warning light(s): to advise when filters need changing.
	Lights: All cooker hoods feature lights to illuminate the cooking area or add to the ambience of the kitchen.		Perimeter extraction panels: very efficient and aid noise reduction.
	Tunable white from warm to cold.		Intensive/turbo setting: when extra fast extraction is required.