

KLT19L4MB





Product family	Hood
Hood Type	Decorative island hood
Design	T flat
Extraction	Extraction
Electronic control	Yes
Material	Painted material + Glass
EAN code	8017709312275
Hood width	90 cm
Aesthetic	Universale
Colour	Matt Black
Glass Type	Black
Logo	Silk screen



Controls

Control setting	Touch control back-lighted White	Led color	White
-----------------	-------------------------------------	-----------	-------

Program / Functions

No. of speeds	3
Intensive speed	
24h air filter function	
Time-setting options	
Auto-vent 2.0	

Technical Features



No. of lights	2	No. of filters	3
Light type	LED	Anti-grease filters	Aluminium
Light Power	7.4 W	Filter replacement indicator	Yes
Dimmer mode	Yes	Vent outlet	150 mm
Light color temperature range	2700 - 4000 K	Minimum distance from GAS hob	750 mm
Free outlet maximum capacity	820 m ³ /h	Minimum distance from ELECTRIC hob	650 mm
Motor power	275 W	Non return valve	Yes

	Extraction rate IEC 61591 [m ³ /h]	Noise level IEC 60704-2-13 [dBA]
Speed 1	214	40
Speed 2	334	51
Speed 3	563	64
Intensive speed	741	70

Accessories included

Tube reduction Yes

Performance / Energy Label



Annual Efficiency Consumption (AEChood)	56 kWh/a	Airbourne acoustical A-weighted sound Power Emission at minimum speed (SPEmin)	39 dBA
Energy efficiency class (EEC)	A	Airborne acoustical A-weighted sound Power Emission at maximum speed (SPEmax)	65 dBA
Fluid Dynamic Efficiency (FDE)	33.1	Airbourne acoustical A-weighted sound power emission at boost speed (SPEboost)	70 dBA
Fluid Dynamic Efficiency class (FDEC)	A	Energy Efficiency Index	51.6
Lighting Efficiency (LE)	21.1 lux/W	Measured air flow rate at best efficiency point (Qbep)	384 m ³ /h
Lighting Efficiency Class (LEC)	B	Measured air pressure at best efficiency point (Pbep)	482 Pa
Grease Filtering Efficiency (GFE)	73.2 %	Measured electric power input at best efficiency point (Wbep)	155 W
Grease Filtering Efficiency Class (GFEC)	D	Nominal Power consumption of the light system (WL)	15 W
Air flow at minumum speed (Qmin)	214 m ³ /h	Average illumination of the light on the cooking surface (Emiddle)	390 lux
Air flow at maximum speed (Qmax)	563 m ³ /h	Sound power level at highest setting (Lwa)	65 dBA
Air flow at boost speed (Qboost)	741 m ³ /h		

Electrical Connection

Electrical connection rating	293 W	Power supply cable length	1500 mm
------------------------------	-------	---------------------------	---------

Voltage	220-240 V	Plug	Not present
Frequency (Hz)	50-60 Hz		

Also available

Alternative colours available	Matt Black	Available colours	KLT19L4MB
-------------------------------	------------	-------------------	-----------

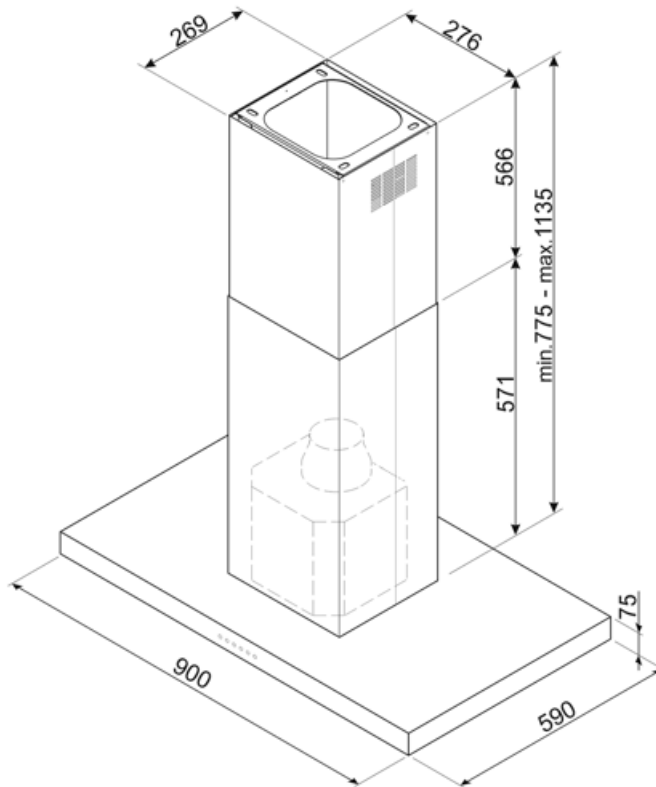

Compatible Accessories

FLT6











Round Charcoal filters (kit 2 pieces)



KITALLFC

Universal Charcoal filter Stainless Steel AISI 304 The filter can be washed in dishwasher 50 °C (water and suitable detergent) and to dry it put in the oven 180°C 25 minutes

Symbols glossary

	24h: When selected this function refreshes the air for c. 10 minutes every hour over a 24 hour period, at minimum speed and an imperceptible noise level.		Filters: Model has filters to help remove grease from the steam emanating from the pans during cooking.
	Energy efficiency class A		Switch off automatically: A special setting, to run after the end of cooking for a pre-set time and then switch off automatically.
	Warning light(s): to advise when filters need changing.		Lights: All cooker hoods feature lights to illuminate the cooking area or add to the ambience of the kitchen.
	Intensive/turbo setting: when extra fast extraction is required.		Connection between hob and hood
	Dimmering Lights		Tunable white from warm to cold.