

KLT19L4MB





Product familie	Dampkap
Type dampkap	Decoratieve eilandkap
Type dampkap	T-vorm plat
Extractie	Extractie
Elektronische bediening	Ja
Materiaal	Geverfd materiaal + Glas
EAN-code	8017709312275
Breedte dampkap	90 cm
Design	Universeel
Kleur	Mat zwart
Type glas	Zwart
Logo	Geëtst



Bediening

Bediening	Touch bediening met witte LED	LED kleur	Wit
-----------	-------------------------------	-----------	-----

Program / Functions

Aantal snelheden	3
Snelheid Intensief	
Luchtzuiveringsfunctie (24 uur)	
Automatische uitschakeling	
Auto-Vent 2.0	

Technische specificaties



Aantal lampen	2	Aantal filters	3
Type lamp	LED	Vetfilters	Aluminium
Vermogen lamp	7.4 W	Indicator vervangen filter	Ja
Dimmerfunctie	Ja	Diameter ventilatie outlet	150 mm
Temperatuur licht aanpasbaar	2700 - 4000 K	Minimum afstand van gaskookplaat	750 mm
Capaciteit P0	820 m ³ /h	Minimum afstand van elektrische kookplaat	650 mm
Vermogen motor	275 W		

Terugslagklep

Ja

	Capaciteit niveau 1 (IEC 61591) [m³/h]	Geluidsniveau niveau 1 (IEC 60704-2-13) [dBA]
Snelheid 1	214	40
Snelheid 2	334	51
Snelheid 3	563	64
Snelheid Intensief	741	70

Meegeleverde accessoires

Reductie pijp Ja

Prestaties / energielabel



Jaarlijkse energieconsumptie (AEC)	56 kWh/jaar	Akoestische geluidsdruk op minimum snelheid (SPEmin)	39 dBA
Energie-efficiëntieklasse (EEC)	A	Akoestische A-gewogen geluidsemissie op maximum snelheid	65 dBA
Hydrodynamische efficiëntieklasse (FDE)	33.1	Akoestische A-gewogen geluidsvermogens in de lucht met intensieve snelheid	70 dBA
Hydrodynamische efficiëntieklasse (FDEC)	A	Energie-efficiëntie Index	51.6
Licht Efficiëntie (LE)	21.1 lux/W	Gemeten luchtdebiet op het beste efficiëntiepunt (Qbep)	384 m³/h
Licht Efficiëntieklasse (LEC)	B	Gemeten luchtdruk op het beste efficiëntiepunt (Pbep)	482 Pa
Vetfilter Efficiëntie (GFE)	73.2 %	Gemeten elektrisch vermogen op het beste efficiëntiepunt (Wbep)	155 W
Vetfilter Efficiëntieklasse (GFEC)	D	Nominaal energieverbruik van de verlichting (WL)	15 W
Debiet luchtafvoer op minimum snelheid (Qmin)	214 m³/h	Gemiddelde verlichting op het kookoppervlak (Emiddle)	390 lux
Luchtstroom bij maximale snelheid (Qmax)	563 m³/h	Geluidsniveau bij de hoogste instelling (Lwa)	65 dBA
Luchtstroom bij intensieve snelheid (Qboost)	741 m³/h		

Elektrische aansluiting

Nominale aansluitwaarde	293 W	Lengte voedingskabel	1500 mm
Spanning	220-240 V	Stekker	Nee
Frequentie	50-60 Hz		

Ook beschikbaar

Andere beschikbare kleuren	Mat zwart	Codes andere beschikbare kleuren	KLT19L4MB
----------------------------	-----------	----------------------------------	-----------

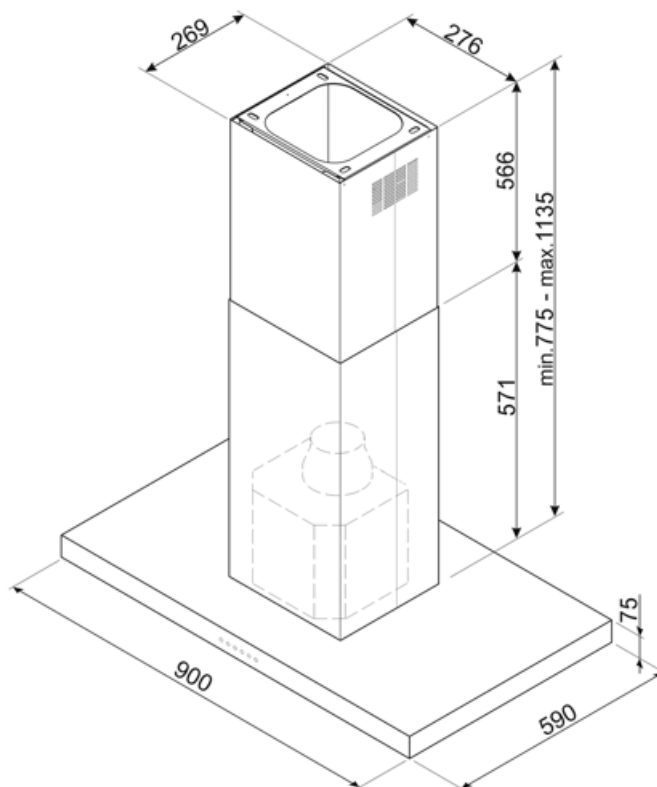

Compatible Accessories

FLT6











Round Charcoal filters (kit 2 pieces)



KITALLFC

Universal Charcoal filter Stainless Steel AISI 304 The filter can be washed in dishwasher 50 °C (water and suitable detergent) and to dry it put in the oven 180°C 25 minutes

Symbols glossary

- | | | | |
|--|---|---|---|
|  | 24h: When selected this function refreshes the air for c. 10 minutes every hour over a 24 hour period, at minimum speed and an imperceptible noise level. |  | Energy efficiency class A |
|  | Filters: Model has filters to help remove grease from the steam emanating from the pans during cooking. |  | Automatisch uitschakelen: Een speciale instelling, om na het einde van de bereiding een vooraf ingestelde tijd te laten lopen en daarna automatisch uit te schakelen. |
|  | Warning light(s): to advise when filters need changing. |  | Lights: All cooker hoods feature lights to illuminate the cooking area or add to the ambience of the kitchen. |
|  | Intensive/turbo setting: when extra fast extraction is required. |  | Connection between hob and hood |
|  | Dimmering Lights |  | Tunable white from warm to cold. |