

KS905SXE2

Product family	Hood
Tipo de Exaustor	Decorative wall hood
Design	T flat
Extraction	Extraction
Electronic control	Yes
Perimeter extraction	No
Material	Stainless steel
Type of steel	Brushed
EAN code	8017709253646
Aesthetic	Linea
Colour	Stainless steel
Acabamento	Satin
Glass Type	Stopsol
Logotipo	Logotipo embutido





Controls



Control setting	Touch control	Display	Yes
Led color	Ice		

Program / Functions

No. of speeds	3
Intensive speed	
24h air filter function	No
Other functions	No
Time-setting options	
Other options	No
Ventilação automática	No

Technical Features



Hood without motor	No	No. of filters	3
Remote motor	No	Anti-grease filters	Aluminium
No. of lights	2	Charcoal filters included	No
Light type	LED	Filter replacement indicator	No
Light Power	1 W	Vent outlet	150 mm
Dimmer mode	Yes	Minimum distance from GAS hob	650 mm

Escala de temperatura de cor clara (°K)	4000 °K	Minimum distance from ELECTRIC hob	650 mm
Free outlet maximum capacity	820 m³/h	Non return valve	Yes
Motor power	275 W		

	Extraction rate IEC 61591 [m³/h]	Noise level IEC 60704-2-13 [dBA]
Speed 1	320	50
Speed 2	401	61
Speed 3	564	65
Intensive speed	767	73

Accessories Included

Remote control	No	Tube reduction	No
Sliding door	No		

Performance / Energy Label



Consumo anual de energia (CAE exaustor)	57 kWh/a	Airborne acoustical A-weighted sound Power Emission at maximum speed (SPEmax)	65 dBA
Energy efficiency class (EEC)	A	Airbourne acoustical A-weighted sound power emission at boost speed (SPEboost)	73 dBA
Fluid Dynamic Efficiency (FDE)	29,8	Power Consumption in Off mode (Po)	0,49 W
Fluid Dynamic Efficiency class (FDEC)	A	Time increase factor (F)	0,9
Lighting Efficiency (LE)	83,2 lux/W	Energy Efficiency Index	52,2
Lighting Efficiency Class (LEC)	A	Measured air flow rate at best efficiency point (Qbep)	402 m³/h
Grease Filtering Efficiency (GFE)	83,2 %	Measured air pressure at best efficiency point (Pbep)	451 Pa
Grease Filtering Efficiency Class (GFEC)	C	Measured electric power input at best efficiency point (Wbep)	169 W
Air flow at minumum speed (Qmin)	320 m³/h	Nominal Power consumption of the light system (WL)	2 W
Air flow at maximum speed (Qmax)	564 m³/h	Average illumination of the light on the cooking surface (Emiddle)	183 lux
Air flow at boost speed (Qboost)	767 m³/h	Sound power level at highest setting (Lwa)	65 dBA
Airbourne acouistical A-weighted sound Power Emission at minimum speed (SPEmin)	50 dBA		

Electrical Connection

Plug	No	Frequency (Hz)	50-60 Hz
Electrical connection rating	278 W	Comprimento do cabo de alimentação	1000 mm
Voltage	220-240 V		

Also available

Outras cores disponíveis Branca, Preta

Códigos das outras cores disponíveis

KS905BXE2 - KS905NXE2

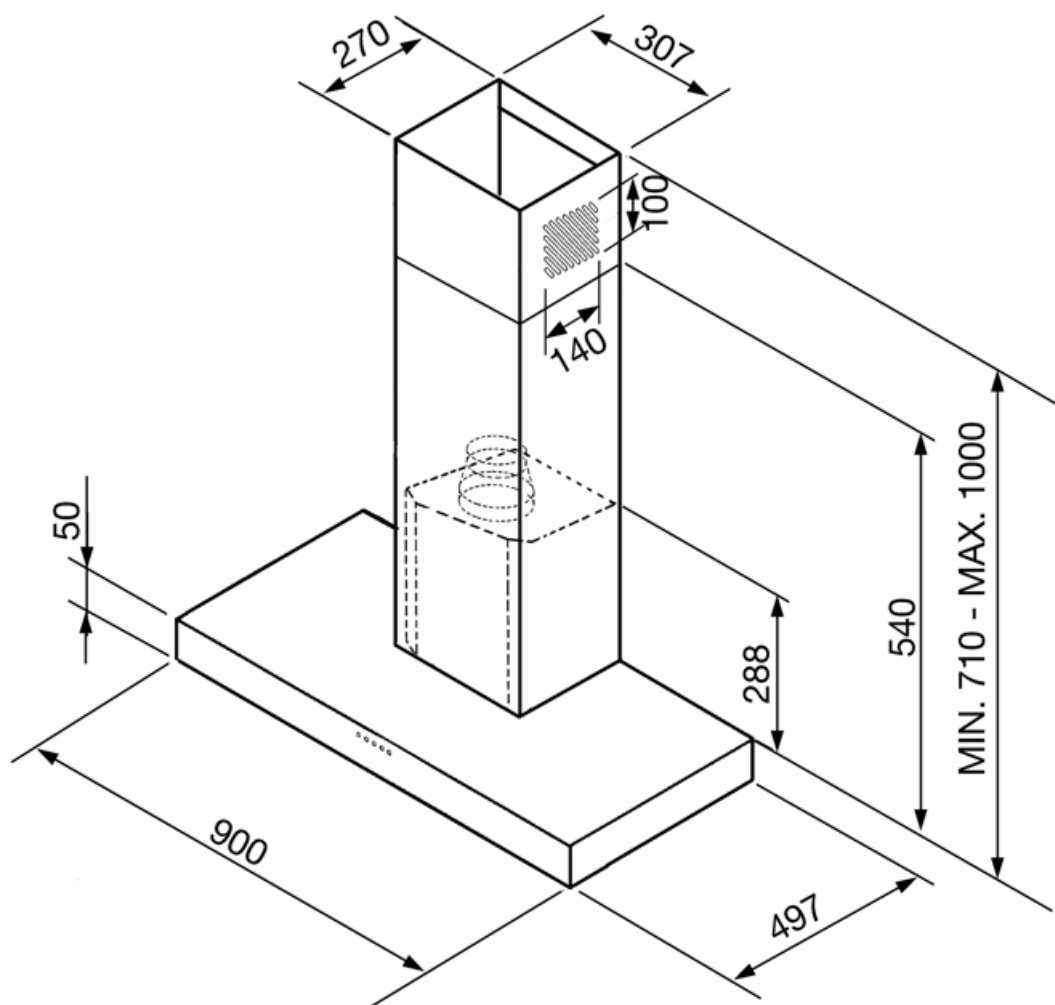

Compatible Accessories



KITALLFC



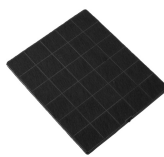





Filtro de carvão universal Aço inoxidável AISI 304 O filtro pode ser lavado na máquina lava-louça a 50 °C (água e detergente adequado) e para secar colocar no forno 180°C 25 minutos



KITFC906

Kit filtro de carvão 1 peça

Symbols glossary

	Filtros: O modelo tem filtros para ajudar a remover a graxa do vapor que emana das panelas durante o cozimento.		Desligar automaticamente: Uma configuração especial, para ser executada após o final do cozimento por um tempo pré-definido e, em seguida, desligar automaticamente.
	R: Desempenho de secagem do produto, medido de A++ a D/G, dependendo da família de produtos		Luzes de escurecimento
	Display LED: para mostrar os programas, funções e opções selecionadas e o tempo até ao final do ciclo.		Luzes: Todos os exaustores possuem luzes para iluminar a área de cozinhar ou adicionar ao ambiente da cozinha.
	Controles táteis: O controles táteis, fáceis de usar, permitem que o aparelho seja programado com o toque de um botão.		Configuração intensiva/turbo: quando a extração extra rápida é necessária.