

KSCB94X







Product familie	Dampkap
Type dampkap	Plafond dampkap
Type dampkap	Plafond dampkap
Extractie	Extractie
Elektronische bediening	Ja
Randafzuiging	Ja
Materiaal	Inox
Type staal	Geborsteld inox
EAN-code	8017709326180
Design	Universeel
Kleur	Inox
Afwerking	Geborsteld inox
Logo	Geëtst



Bediening

Bediening	Touch bediening met witte LED
-----------	-------------------------------

Program / Functions

Aantal snelheden	3
Snelheid Intensief	
Luchtzuiveringsfunctie (24 uur)	
Automatische uitschakeling	
Auto-Vent 2.0	

Technische specificaties



Aantal lampen	4	Aantal filters	2
Type lamp	LED	Vetfilters	Inox
Vermogen lamp	2.3 W	Indicator vervangen filter	Ja
Dimmerfunctie	Ja	Diameter ventilatie outlet	150 mm
Temperatuur licht (Kelvin)	3000 °K	Minimum afstand van gaskookplaat	750 mm
Temperatuur licht aanpasbaar	2700° - 4000° °K	Minimum afstand van elektrische kookplaat	650 mm
Capaciteit P0	820 m³/h		
Vermogen motor	275 W		

Terugslagklep

Ja

	Capaciteit niveau 1 (IEC 61591) [m³/h]	Geluidsniveau niveau 1 (IEC 60704-2-13) [dBA]
Snelheid 1	268	45
Snelheid 2	360	55
Snelheid 3	624	65
Snelheid Intensief	798	70

Meegeleverde accessoires

Afstandsbediening inbegrepen Ja

Prestaties / energielabel



Jaarlijkse energieconsumptie (AEC)	45 kWh/jaar	Akoestische A-gewogen geluidsemissie op maximum snelheid	66 dBA
Energie-efficiëntieklasse (EEC)	A+	Akoestische A-gewogen geluidsvermogens in de lucht met intensieve snelheid	70 dBA
Hydrodynamische efficiëntieklasse (FDE)	35,3	Vermogensverbruik in Stand-by modus	0,49 W
Hydrodynamische efficiëntieklasse (FDEC)	A	Tijdverhogingsfactor (F)	0,7
Licht Efficiëntie (LE)	26,6 lux/W	Energie-efficiëntie Index	43,8
Licht Efficiëntieklasse (LEC)	B	Gemeten luchtdebiet op het beste efficiëntiepunt (Qbep)	407 m³/h
Vetfilter Efficiëntie (GFE)	51,6 %	Gemeten luchtdruk op het beste efficiëntiepunt (Pbep)	472 Pa
Vetfilter Efficiëntieklasse (GFEC)	F	Gemeten elektrisch vermogen op het beste efficiëntiepunt (Wbep)	151 W
Debiet luchtafvoer op minimum snelheid (Qmin)	268 m³/h	Nominaal energieverbruik van de verlichting (WL)	9 W
Luchtstroom bij maximale snelheid (Qmax)	624 m³/h	Gemiddelde verlichting op het kookoppervlak (Emiddle)	245 lux
Luchtstroom bij intensieve snelheid (Qboost)	798 m³/h	Geluidsniveau bij de hoogste instelling (Lwa)	66 dBA
Akoestische geluidsdruk op minimum snelheid (SPEmin)	45 dBA		

Elektrische aansluiting

Nominale aansluitwaarde 285 W
Spanning 220-240 V

Frequentie 50-60 Hz
Lengte voedingskabel 1500 mm

Ook beschikbaar

Andere beschikbare kleuren

Wit

Codes andere beschikbare kleuren

KSCB94WH

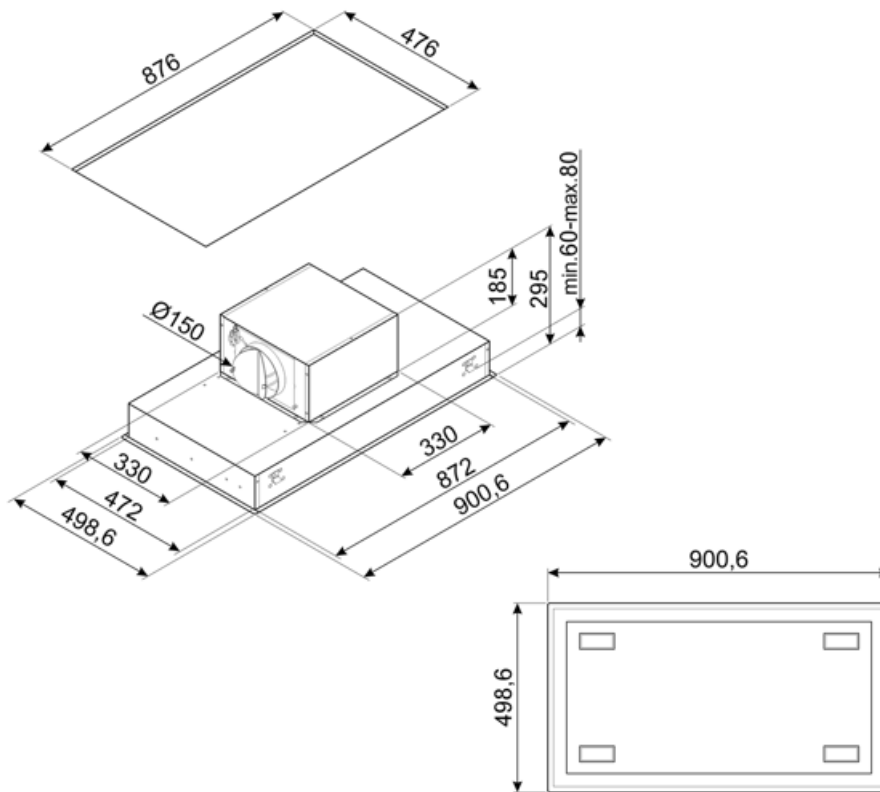

Compatible Accessories

FLT6











Round Charcoal filters (kit 2 pieces)



KITALLFC

Universal Charcoal filter Stainless Steel AISI 304 The filter can be washed in dishwasher 50 °C (water and suitable detergent) and to dry it put in the oven 180°C 25 minutes

Symbols glossary

- | | | | |
|---|---|---|---|
|  | 24h: When selected this function refreshes the air for c. 10 minutes every hour over a 24 hour period, at minimum speed and an imperceptible noise level. |  | A+: Energy efficiency class A+ helps to save up to 10% energy compared to class A. Maximum performance with minimum consumption is guaranteed. |
|  | Filters: Model has filters to help remove grease from the steam emanating from the pans during cooking. |  | Automatisch uitschakelen: Een speciale instelling, om na het einde van de bereiding een vooraf ingestelde tijd te laten lopen en daarna automatisch uit te schakelen. |
|  | Warning light(s): to advise when filters need changing. |  | Lights: All cooker hoods feature lights to illuminate the cooking area or add to the ambience of the kitchen. |
|  | Perimeter extraction panels: very efficient and aid noise reduction. |  | Intensive/turbo setting: when extra fast extraction is required. |
|  | Connection between hob and hood |  | Dimmering Lights |
|  | Tunable white from warm to cold | | |