

# KSDD90VN-2

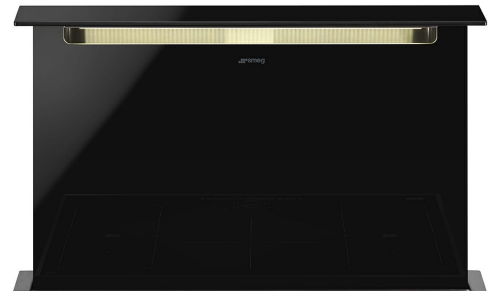

Product family	Hood
Hood Type	DownDraft
Design	Fully integrated
Extraction	Extraction
Electronic control	Yes
Perimeter extraction	Yes
Material	Stainless Steel + Glass
Type of steel	Brushed
EAN code	8017709239336
Hood width	90 cm



## Aesthetics

Aesthetic	Dolce Stil Novo	Glass Type	Black
Colour	Black	Serigraphy colour	White
Finishing	Glass	Logo	Silk screen



## Controls

Control setting	Remote Control
-----------------	----------------

## Programs / Functions

No. of speeds	3
Intensive speed	
Time-setting options	

## Technical Features

		Remote motor	Included	Motor power	285 W
		No. of lights	1	No. of filters	2
		Light type	LED	Anti-grease filters	stainless steel 7 layer
		Light Power	6 W	Vent outlet	150 mm
		Light color temperature scale (°K)	4000 °K	Non return valve	Yes

Free outlet maximum capacity 800 m<sup>3</sup>/h

	Extraction rate IEC 61591 [m <sup>3</sup> /h]	Noise level IEC 60704-2-13 [dB(A)]
Speed 1	230	42
Speed 2	322	50
Speed 3	500	59
Intensive speed	730	66

## Accessories Included

Remote control Yes Motorised opening Yes

## Performance / Energy Label

A	
Annual Efficiency Consumption (AEChood)	60 kWh/a
Energy efficiency class (EEC)	A
Fluid Dynamic Efficiency (FDE)	29,5
Fluid Dynamic Efficiency class (FDEC)	A
Lighting Efficiency (LE)	15,0 lux/W
Lighting Efficiency Class (LEC)	D
Grease Filtering Efficiency (GFE)	38,9 %
Grease Filtering Efficiency Class (GFEC)	G
Air flow at minimum speed (Qmin)	213 m <sup>3</sup> /h
Air flow at maximum speed (Qmax)	448 m <sup>3</sup> /h
Air flow at boost speed (Qboost)	724 m <sup>3</sup> /h
Airborne acoustical A-weighted sound Power Emission at minimum speed (SPEmin)	40 dB(A)
Airborne acoustical A-weighted sound Power Emission at maximum speed (SPEmax)	57 dB(A)
Airborne acoustical A-weighted sound power emission at boost speed (SPEboost)	65 dB(A)
Time increase factor (F)	1,00
Energy Efficiency Index	53,1
Measured air flow rate at best efficiency point (Qbep)	349 m <sup>3</sup> /h
Measured air pressure at best efficiency point (Pbep)	464 Pa
Measured electric power input at best efficiency point (Wbep)	147 W
Nominal Power consumption of the light system (WL)	6 W
Average illumination of the light on the cooking surface (Emiddle)	253 lux
Sound power level at highest setting (Lwa)	57 dB(A)

## Electrical Connection

Electrical connection rating 292 W  
Voltage 220-240 V

Frequency (Hz) 50-60 Hz  
Power supply cable length 1000 mm

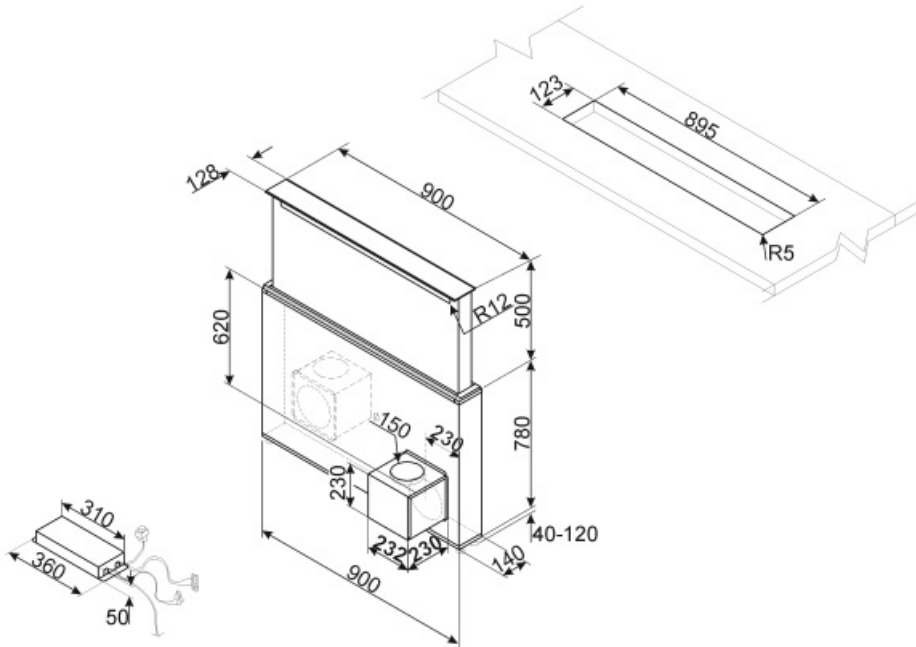

---

## Not included accessories

---

### KITKDSNBG

HOOD FRAME BLACK GLASS AND SS.  
FLUSH INSTALLATION KSDD90VN-2



### KITKDSNX

HOOD FRAME BLACK GLASS WITH  
STAINLESS STEEL PROFILE FLAT  
INSTALLATION KSDD90VN-2



### FLTDSN90



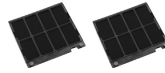



Charcoal filter Kit 2 pieces  
(20x460x190 mm)



---

## Symbols glossary (TT)

---

- |  |  |   |   |
|--|--|---|---|
|  | A: Product drying performance, measured from A+++ to D / G depending on the product family   |  | Filters: Model has filters to help remove grease from the steam emanating from the pans during cooking.       |
|  | Switch off automatically: A special setting, to run after the end of cooking for a pre-set time and then switch off automatically. |  | Lights: All cooker hoods feature lights to illuminate the cooking area or add to the ambience of the kitchen. |
|  | Perimeter extraction panels: very efficient and aid noise reduction.   |  | Intensive/turbo setting: when extra fast extraction is required.  |