

# KSG8P4X







Product familie	Dampkap
Type dampkap	Inbouwdampkap
Type dampkap	Volledig integreerbaar
Extractie	Extractie
Elektronische bediening	Ja
Randafzuiging	Ja
Materiaal	Inox
Type staal	Geborsteld inox
EAN-code	8017709319373
Breedte dampkap	75 cm
Design	Universeel
Kleur	Inox
Afwerking	Geborsteld inox
Logo	Geëtst



## Bediening

Bediening	Touch bediening met witte LED	LED kleur	Wit
-----------	-------------------------------	-----------	-----

## Program / Functions

Aantal snelheden	3
Snelheid Intensief	
Luchtzuiveringsfunctie (24 uur)	
Automatische uitschakeling	
Auto-Vent 2.0	

## Technische specificaties



Aantal lampen	2	Aantal filters	2
Type lamp	LED	Vetfilters	Aluminium
Vermogen lamp	2,3 W	Indicator vervangen filter	Ja
Dimmerfunctie	Ja	Diameter ventilatie outlet	150 mm
Temperatuur licht aanpasbaar	2700 - 4000 K	Minimum afstand van gaskookplaat	650 mm
Capaciteit P0	730 m <sup>3</sup> /h	Minimum afstand van elektrische kookplaat	650 mm
Vermogen motor	230 W		

Terugslagklep

Ja

	Capaciteit niveau 1 (IEC 61591) [m <sup>3</sup> /h]	Geluidsniveau niveau 1 (IEC 60704-2-13) [dBA]
Snelheid 1	266	46
Snelheid 2	356	52
Snelheid 3	480	60
Snelheid Intensief	681	67

## Prestaties / energielabel



Jaarlijkse energieconsumptie (AEC)	53 kWh/jaar	Akoestische geluidsdruk op minimum snelheid (SPEmin)	46 dBA
Energie-efficiëntieklasse (EEC)	A	Akoestische A-gewogen geluidsemmissie op maximum snelheid	60 dBA
Hydrodynamische efficiëntieklasse (FDE)	29,7	Akoestische A-gewogen geluidsvermogens in de lucht met intensieve snelheid	67 dBA
Hydrodynamische efficiëntieklasse (FDEC)	A	Tijdverhogingsfactor (F)	0,9
Licht Efficiëntie (LE)	38,0 lux/W	Energie-efficiëntie Index	52,5
Licht Efficiëntieklasse (LEC)	A	Gemeten luchtdebiet op het beste efficiëntiepunt (Qbep)	356 m <sup>3</sup> /h
Vetfilter Efficiëntie (GFE)	73,8 %	Gemeten luchtdruk op het beste efficiëntiepunt (Pbep)	448 Pa
Vetfilter Efficiëntieklasse (GFEC)	D	Gemeten elektrisch vermogen op het beste efficiëntiepunt (Wbep)	149 W
Debiet luchtafvoer op minimum snelheid (Qmin)	266 m <sup>3</sup> /h	Nominaal energieverbruik van de verlichting (WL)	5 W
Luchtstroom bij maximale snelheid (Qmax)	480 m <sup>3</sup> /h	Gemiddelde verlichting op het kookoppervlak (Emiddle)	175 lux
Luchtstroom bij intensieve snelheid (Qboost)	681 m <sup>3</sup> /h	Geluidsniveau bij de hoogste instelling (Lwa)	60 dBA

## Elektrische aansluiting

Nominale aansluitwaarde	235 W	Lengte voedingskabel	1500 mm
Spanning	220-240 V	Stekker	Nee
Frequentie	50-60 Hz		

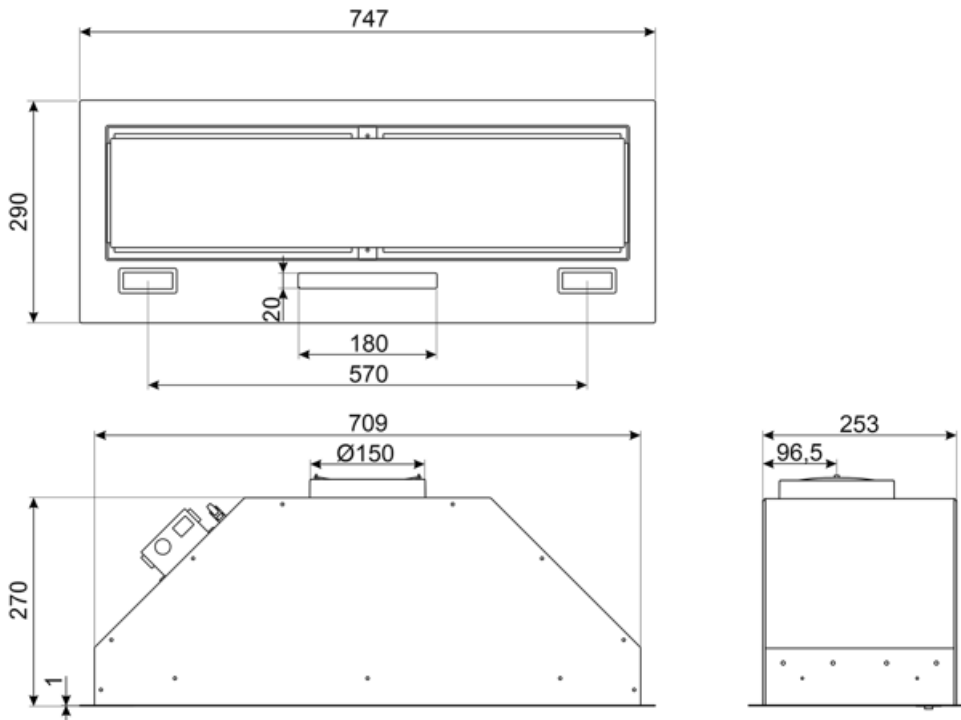

---

## Compatible Accessories

---



### FLT6











Round Charcoal filters (kit 2 pieces)



### KITALLFC

Universal Charcoal filter Stainless Steel AISI 304 The filter can be washed in dishwasher 50 °C (water and suitable detergent) and to dry it put in the oven 180°C 25 minutes

## Symbols glossary

	24h: When selected this function refreshes the air for c. 10 minutes every hour over a 24 hour period, at minimum speed and an imperceptible noise level.		Energy efficiency class A
	Filters: Model has filters to help remove grease from the steam emanating from the pans during cooking.		Automatisch uitschakelen: Een speciale instelling, om na het einde van de bereiding een vooraf ingestelde tijd te laten lopen en daarna automatisch uit te schakelen.
	Warning light(s): to advise when filters need changing.		Lights: All cooker hoods feature lights to illuminate the cooking area or add to the ambience of the kitchen.
	Perimeter extraction panels: very efficient and aid noise reduction.		Intensive/turbo setting: when extra fast extraction is required.
	Connection between hob and hood		Dimmering Lights
	Tunable white from warm to cold.		