

KSG9P4MB







Product familie	Dampkap
Type dampkap	Inbouwdampkap
Type dampkap	Volledig integreerbaar
Extractie	Extractie
Elektronische bediening	Ja
Randafzuiging	Ja
Materiaal	Inox
Type staal	Geborsteld inox
EAN-code	8017709336301
Design	Universeel
Kleur	Mat zwart
Afwerking	Geborsteld inox
Logo	Geëtst



Bediening

Bediening	Touch bediening met witte LED	LED kleur	Wit
-----------	-------------------------------	-----------	-----

Program / Functions

Aantal snelheden	3
Snelheid Intensief	
Luchtzuiveringsfunctie (24 uur)	
Automatische uitschakeling	
Auto-Vent 2.0	

Technische specificaties



Aantal lampen	2	Aantal filters	2
Type lamp	LED	Vetfilters	Aluminium
Vermogen lamp	2.3 W	Indicator vervangen filter	Ja
Dimmerfunctie	Ja	Diameter ventilatie outlet	150 mm
Temperatuur licht aanpasbaar	2700° - 4000° K	Minimum afstand van gaskookplaat	650 mm
Capaciteit P0	730 m ³ /h	Minimum afstand van elektrische kookplaat	650 mm
Vermogen motor	230 W		

Terugslagklep

Ja

	Capaciteit niveau 1 (IEC 61591) [m ³ /h]	Geluidsniveau niveau 1 (IEC 60704-2-13) [dBA]
Snelheid 1	243	45
Snelheid 2	362	53
Snelheid 3	481	59
Snelheid Intensief	697	67

Prestaties / energielabel



Jaarlijkse energieconsumptie (AEC)	53 KWh/jaar	Akoestische A-gewogen geluidsemisatie op maximum snelheid	60 dBA
Energie-efficiëntieklasse (EEC)	A	Akoestische A-gewogen geluidsvermogens in de lucht met intensieve snelheid	67 dBA
Hydrodynamische efficiëntieklasse (FDE)	30,1	Vermogensverbruik in Off modus (Po)	0,49 W
Hydrodynamische efficiëntieklasse (FDEC)	A	Tijdverhogingsfactor (F)	0,9
Licht Efficiëntie (LE)	31,1 lux/W	Energie-efficiëntie Index	52,6
Licht Efficiëntieklasse (LEC)	A	Gemeten luchtdebiet op het beste efficiëntiepunt (Qbep)	369 m ³ /h
Vetfilter Efficiëntie (GFE)	77,9 %	Gemeten luchtdruk op het beste efficiëntiepunt (Pbep)	446 Pa
Vetfilter Efficiëntieklasse (GFEC)	C	Gemeten elektrisch vermogen op het beste efficiëntiepunt (Wbep)	152 W
Debiet luchtafvoer op minimum snelheid (Qmin)	242 m ³ /h	Nominaal energieverbruik van de verlichting (WL)	5 W
Luchtstroom bij maximale snelheid (Qmax)	481 m ³ /h	Gemiddelde verlichting op het kookoppervlak (Emiddle)	143 lux
Luchtstroom bij intensieve snelheid (Qboost)	697 m ³ /h	Geluidsniveau bij de hoogste instelling (Lwa)	60 dBA
Akoestische geluidsdruk op minimum snelheid (SPEmin)	45 dBA		

Elektrische aansluiting

Nominale aansluitwaarde	235 W	Frequentie	50-60 Hz
Spanning	220-240 V	Lengte voedingskabel	1500 mm

Ook beschikbaar

Andere beschikbare
kleuren

Inox

Codes andere
beschikbare kleuren

KSG9P4X

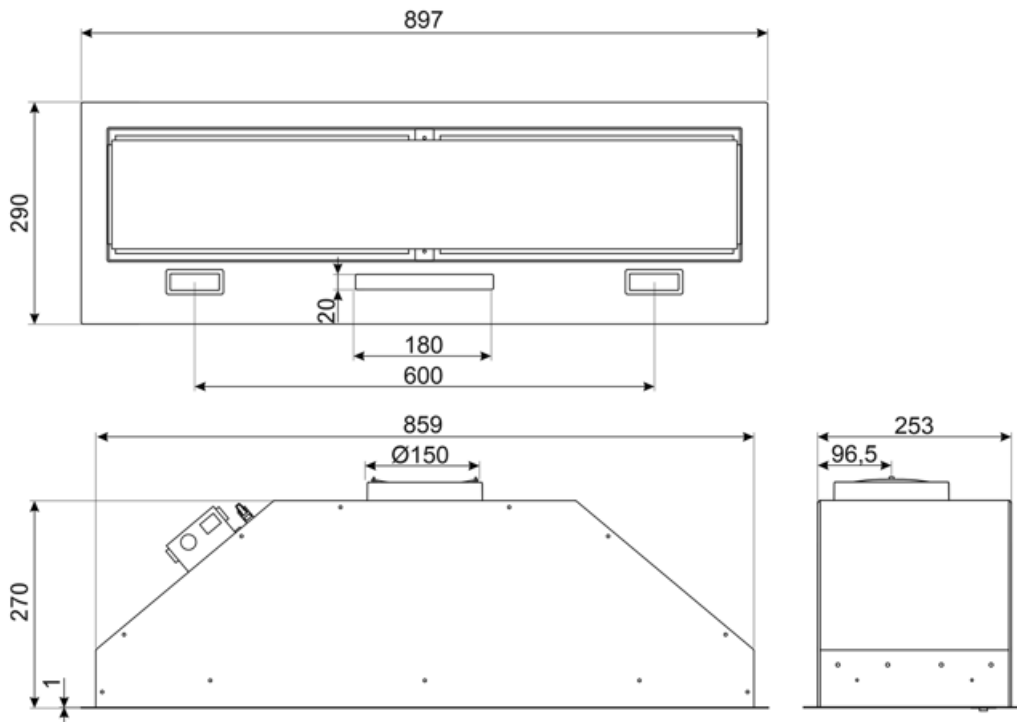

Compatible Accessories

FLT6











Round Charcoal filters (kit 2 pieces)



KITALLFC

Universal Charcoal filter Stainless Steel AISI 304 The filter can be washed in dishwasher 50 °C (water and suitable detergent) and to dry it put in the oven 180°C 25 minutes

Symbols glossary

- | | | | |
|---|---|---|---|
|  | 24h: When selected this function refreshes the air for c. 10 minutes every hour over a 24 hour period, at minimum speed and an imperceptible noise level. |  | |
|  | Filters: Model has filters to help remove grease from the steam emanating from the pans during cooking. |  | Automatisch uitschakelen: Een speciale instelling, om na het einde van de bereiding een vooraf ingestelde tijd te laten lopen en daarna automatisch uit te schakelen. |
|  | Warning light(s): to advise when filters need changing. |  | Lights: All cooker hoods feature lights to illuminate the cooking area or add to the ambience of the kitchen. |
|  | Perimeter extraction panels: very efficient and aid noise reduction. |  | Intensive/turbo setting: when extra fast extraction is required. |
|  | Connection between hob and hood |  | Dimmering Lights |
|  | Tunable white from warm to cold | | |

Benefit (TT)

Perimetral aspiration

Optimized extraction through the perimeter aspiration system

Perimeter aspiration enhances extraction efficiency by directing vapors along the edges of the panel beneath the filters, optimizing air capture

Dimmering & Tunable lights

Customized lighting with LED lights featuring adjustable intensity and color temperature, from warm to cool tones

Touch display back lighted white

Intuitive and immediate usability thanks to the elegant white LED backlit touch display

Autovent 2.0

Centralized and practical control via Bluetooth connection between hob and hood

The Auto-Vent 2.0 system enables automatic hood management through connection with the hob: both appliances switch on simultaneously, and the extraction power adjusts in real time to the cooking intensity.