

KSLS10MB







Product family	Hood
Hood Type	Decorative island hood
Design	Suspended
Extraction	Recirculation
Electronic control	Yes
Perimeter extraction	Yes
Material	Aluminium
Type of steel	Brushed
EAN code	8017709351885
Hood width	100 cm
Aesthetic	Isola
Colour	Matt Black
Finishing	Satin
Glass Type	Black
Serigraphy colour	Grey
Logo	Silk screen



Controls

Control setting	Touch on metal	Led color	White
------------------------	----------------	------------------	-------

Program / Functions

No. of speeds	3
Intensive speed	
24h air filter function	
Other functions	
 Delay_function	
Time-setting options	
Auto-vent 2.0	
H-Condense System	Yes

Technical Features

   	No. of lights	2	Motor power	39 W
	Light type	LED	No. of filters	2
	Light Power	36 W	Anti-grease filters	Aluminium

Dimmer mode	Yes	Filter replacement indicator	Yes
Light color temperature range	2700 - 6500 K	Minimum distance from GAS hob	650 mm
Free outlet maximum capacity	650 m ³ /h	Minimum distance from ELECTRIC hob	550 mm

	Extraction rate IEC 61591 [m³/h]	Noise level IEC 60704-2-13 [dBA]
Speed 1	120	45
Speed 2	200	58
Speed 3	420	65
Intensive speed	650	73

Accessories included

Remote control	Yes	Charcoal filters included	Yes regenerable
Tube reduction	Yes		

Electrical Connection

Battery type	Alkaline-Manganese Dioxide (Zn/MnO ₂)	Frequency (Hz)	50-60 Hz
Electrical connection rating	291 W	Power supply cable length	3500 mm
Voltage	220-240 V	Plug	Not present

Also available

Alternative colours available	Stainless steel	Available colours	KSL10X
--------------------------------------	-----------------	--------------------------	--------

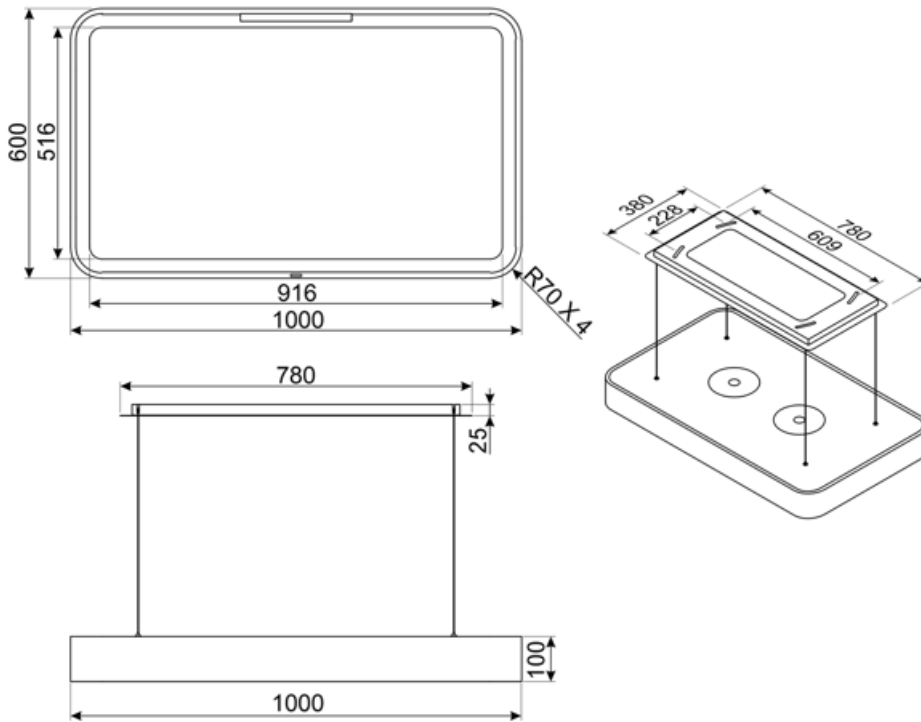











Alternative products



KSL10X

Colour: Stainless steel

Symbols glossary

	24h: When selected this function refreshes the air for c. 10 minutes every hour over a 24 hour period, at minimum speed and an imperceptible noise level.		Filters: Model has filters to help remove grease from the steam emanating from the pans during cooking.
	Connection between hob and hood		Switch off automatically: A special setting, to run after the end of cooking for a pre-set time and then switch off automatically.
	Delay timer: can be set to run the programme at a convenient time or to take advantage of off-peak energy periods.		Dimmering Lights
	Warning light(s): to advise when filters need changing.		Lights: All cooker hoods feature lights to illuminate the cooking area or add to the ambience of the kitchen.
	Perimeter extraction panels: very efficient and aid noise reduction.		Intensive/turbo setting: when extra fast extraction is required.