

# KSLS18MB







Product family	Hood
Hood Type	Decorative island hood
Design	Suspended
Extraction	Recirculation
Electronic control	Yes
Perimeter extraction	Yes
Material	Aluminium
EAN code	8017709351908
Hood width	180 cm
Aesthetic	Isola
Colour	Matt Black
Finishing	Satin
Glass Type	Black
Serigraphy colour	Grey
Logo	Silk screen



## Controls

Control setting	Touch on metal	Led color	White
-----------------	----------------	-----------	-------

## Program / Functions

No. of speeds	3
Intensive speed	
24h air filter function	
Other functions	
 Delay_function	
Time-setting options	
Auto-vent 2.0	
H-Condense System	Yes

## Technical Features

				No. of lights	2	Motor power	48 W
				Light type	LED	No. of filters	2
				Light Power	48 W	Anti-grease filters	Aluminium
				Dimmer mode	Yes		

**Light color temperature range** 2700 - 6500 K

**Free outlet maximum capacity** 650 m<sup>3</sup>/h

**Filter replacement indicator** Yes

**Minimum distance from GAS hob** 650 mm

**Minimum distance from ELECTRIC hob** 550 mm

	<b>Extraction rate IEC 61591 [m<sup>3</sup>/h]</b>	<b>Noise level IEC 60704-2-13 [dBA]</b>
Speed 1	120	43
Speed 2	200	58
Speed 3	420	65
Intensive speed	650	73

## Accessories included

**Remote control** Yes

**Charcoal filters included** Yes regenerable

## Electrical Connection

**Battery type** Alkaline-Manganese Dioxide (Zn/MnO<sub>2</sub>)

**Electrical connection rating** 291 W

**Voltage** 220-240 V

**Frequency (Hz)** 50-60 Hz

**Power supply cable length** 3500 mm

**Plug** Not present

## Also available

**Alternative colours available** Stainless steel

**Available colours** KSL18X

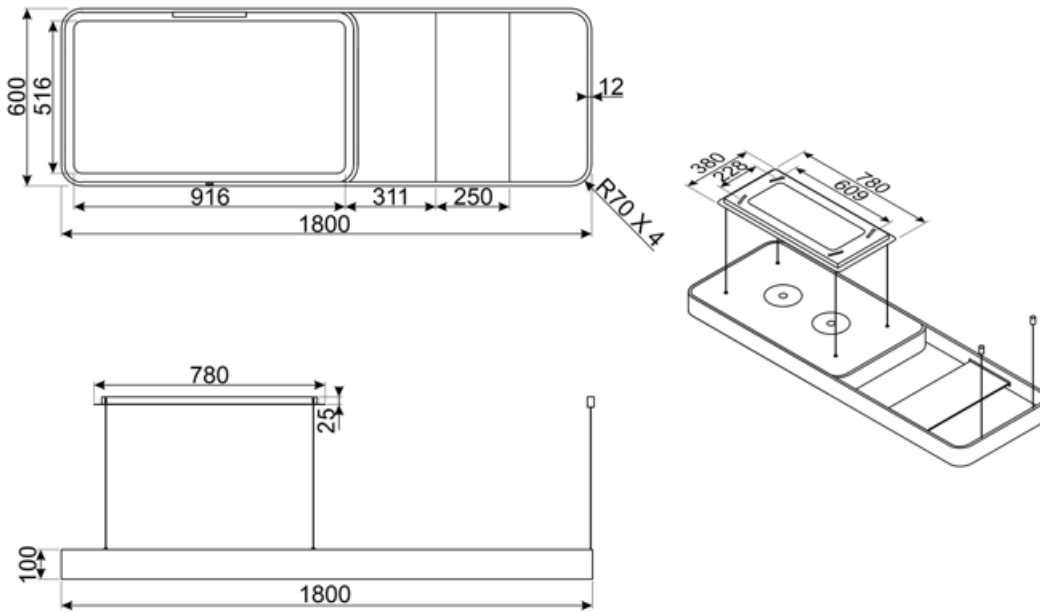

---

## Alternative products











---

**KSLS18X**

**Colour: Stainless Steel and Glass**



## Symbols glossary

	24h: When selected this function refreshes the air for c. 10 minutes every hour over a 24 hour period, at minimum speed and an imperceptible noise level.		Filters: Model has filters to help remove grease from the steam emanating from the pans during cooking.
	Switch off automatically: A special setting, to run after the end of cooking for a pre-set time and then switch off automatically.		Delay timer: can be set to run the programme at a convenient time or to take advantage of off-peak energy periods.
	Warning light(s): to advise when filters need changing.		Lights: All cooker hoods feature lights to illuminate the cooking area or add to the ambience of the kitchen.
	Perimeter extraction panels: very efficient and aid noise reduction.		Intensive/turbo setting: when extra fast extraction is required.
	Connection between hob and hood		Dimmering Lights