

KV194B3







Product familie	Dampkap
Type dampkap	Decoratieve muurdampkap
Type dampkap	Verticaal
Extractie	Extractie
Elektronische bediening	Ja
Randafzuiging	Ja
Materiaal	Glas
EAN-code	8017709327903
Breedte dampkap	90 cm
Design	Linea
Kleur	Zwart
Afwerking	Glas
Type glas	Zwart
Kleur serigrafie	Grijs
Logo	Geëtst



Bediening

Bediening	Touch bediening met witte LED	LED kleur	Wit
-----------	-------------------------------	-----------	-----

Program / Functions

Aantal snelheden	3
Snelheid Intensief	
Luchtzuiveringsfunctie (24 uur)	
Automatische uitschakeling	
Auto-Vent 2.0	

Technische specificaties



Aantal lampen	2	Aantal filters	2
Type lamp	LED	Vetfilters	Inox
Vermogen lamp	2,1 W	Indicator vervangen filter	Ja
Dimmerfunctie	Ja	Diameter ventilatie outlet	150 mm
Temperatuur licht aanpasbaar	2700 - 4000 K	Minimum afstand van gaskookplaat	650 mm
Capaciteit P0	820 m ³ /h		
Vermogen motor	275 W		

Minimum afstand van elektrische kookplaat	450 mm
Terugslagklep	Ja

	Capaciteit niveau 1 (IEC 61591) [m³/h]	Geluidsniveau niveau 1 (IEC 60704-2-13) [dBA]
Snelheid 1	277	50
Snelheid 2	406	63
Snelheid 3	636	70
Snelheid Intensief	782	72

Meegeleverde accessoires



Meegeleverde koolstoffilters Ja

Prestaties / energielabel



Jaarlijkse energieconsumptie (AEC)	41 kWh/jaar	Akoestische geluidsdruk op minimum snelheid (SPEmin)	50 dBA
Energie-efficiëntieklasse (EEC)	A+	Akoestische A-gewogen geluidsemissie op maximum snelheid	70 dBA
Hydrodynamische efficiëntieklasse (FDE)	36,2	Akoestische A-gewogen geluidsvermogens in de lucht met intensieve snelheid	72 dBA
Hydrodynamische efficiëntieklasse (FDEC)	A	Tijdverhogingsfactor (F)	0,7
Licht Efficiëntie (LE)	34,8 lux/W	Energie-efficiëntie Index	41,2
Licht Efficiëntieklasse (LEC)	A	Gemeten luchtdebiet op het beste efficiëntiepunt (Qbep)	403 m³/h
Vetfilter Efficiëntie (GFE)	64,3 %	Gemeten luchtdruk op het beste efficiëntiepunt (Pbep)	479 Pa
Vetfilter Efficiëntieklasse (GFEC)	E	Gemeten elektrisch vermogen op het beste efficiëntiepunt (Wbep)	148 W
Debiet luchtafvoer op minimum snelheid (Qmin)	277 m³/h	Nominaal energieverbruik van de verlichting (WL)	5 W
Luchtstroom bij maximale snelheid (Qmax)	636 m³/h	Gemiddelde verlichting op het kookoppervlak (Emiddle)	139 lux
Luchtstroom bij intensieve snelheid (Qboost)	782 m³/h		

Geluidsniveau bij de
hoogste instelling (Lwa) 71 dBA

Elektrische aansluiting

Nominale
aansluitwaarde 279 W
Spanning 220-240 V
Frequentie 50-60 Hz

Lengte voedingskabel 1500 mm
Stekker Nee

Ook beschikbaar

Andere beschikbare
kleuren Neptune Grey

Codes andere
beschikbare kleuren KV194G

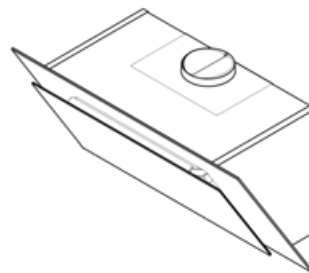
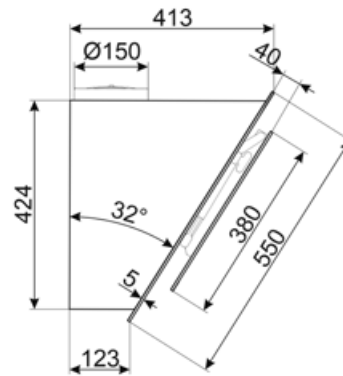
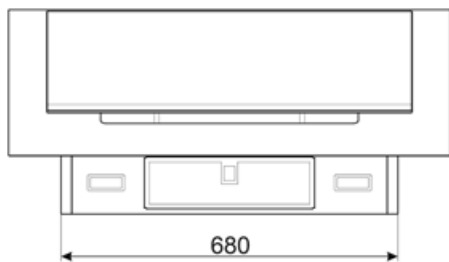
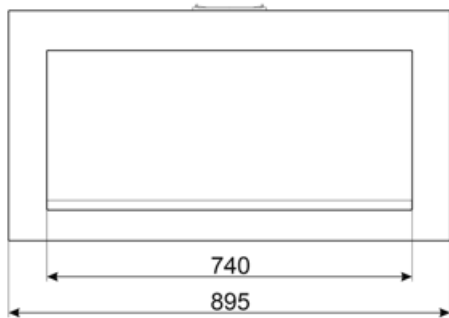

Compatible Accessories



KITALLFC

Universal Charcoal filter Stainless Steel AISI 304 The filter can be washed in dishwasher 50 °C (water and suitable detergent) and to dry it put in the oven 180°C 25 minutes



KITCMNKVX

Chimney Extension in Stainless Steel for hood KV*series Dimensions 300x200x850 mm



KITCMNKVMB













Chimney Extension in Stainless Steel for hood KV*series 300 mm*200 mm + 500/850 mm



KITFCKV1

Kit 2 pcs Charcoal Filter for Hood KV1*series. Dishwasher-safe. Size 320x80 mm and 280 x280 mm.

Symbols glossary

	24h: When selected this function refreshes the air for c. 10 minutes every hour over a 24 hour period, at minimum speed and an imperceptible noise level.		Filters: Model has filters to help remove grease from the steam emanating from the pans during cooking.
	A+: Energy efficiency class A+ helps to save up to 10% energy compared to class A. Maximum performance with minimum consumption is guaranteed.		Automatisch uitschakelen: Een speciale instelling, om na het einde van de bereiding een vooraf ingestelde tijd te laten lopen en daarna automatisch uit te schakelen.
	Charcoal filters: Extracting through charcoal filters or directly to the exterior lessens strong cooking odours considerably.		Warning light(s): to advise when filters need changing.
	Lights: All cooker hoods feature lights to illuminate the cooking area or add to the ambience of the kitchen.		Perimeter extraction panels: very efficient and aid noise reduction.
	Intensive/turbo setting: when extra fast extraction is required.		Connection between hob and hood
	Dimming Lights		Tunable white from warm to cold.