

KV194G



Product familie	Dampkap
Type dampkap	Decoratieve muurdampkap
Type dampkap	Verticaal
Extractie	Extractie
Elektronische bediening	Ja
Randafzuiging	Ja
Materiaal	Glas
EAN-code	8017709327897
Breedte dampkap	90 cm







Design

Design	Linea	Type glas	Zwart
Kleur	Neptune Grey	Kleur serigrafie	Grijs
Afwerking	Glas	Logo	Geëtst

Bediening

Bediening	Touch bediening met witte LED	LED kleur	Wit
-----------	-------------------------------	-----------	-----

Programma's / Functies

Aantal snelheden	3
Snelheid Intensief	
Luchtzuiveringsfunctie (24 uur)	
Automatische uitschakeling	
Auto-Vent 2.0	

Technische specificaties

					
Aantal lampen	2				
Type lamp	LED				

Vetfilters	Inox
Meegeleverde koolstoffilters	Ja

Vermogen lamp	2.1 W	Indicator vervangen filter	Ja
Dimmerfunctie	Ja	Diameter ventilatie outlet	150 mm
Temperatuur licht aanpasbaar	2700° - 4000° °K	Minimum afstand van gaskookplaat	650 mm
Capaciteit P0	820 m ³ /h	Minimum afstand van elektrische kookplaat	450 mm
Vermogen motor	275 W	Terugslagklep	Ja
Aantal filters	2		

	Capaciteit niveau 1 (IEC 61591) [m ³ /h]	Geluidsniveau niveau 1 (IEC 60704-2-13) [dB(A)]
Snelheid 1	277	50
Snelheid 2	406	63
Snelheid 3	636	70
Snelheid Intensief	782	72

Prestaties / energielabel

A*

Jaarlijkse energieconsumptie (AEC)	41 kWh/jaar	Akoestische A-gewogen geluidsemissie op maximum snelheid	71 dB(A)
Energie-efficiëntieklasse (EEC)	A+	Akoestische A-gewogen geluidsvermogens in de lucht met intensieve snelheid	72 dB(A)
Hydrodynamische efficiëntieklasse (FDE)	36.2	Vermogensverbruik in Off modus (Po)	0.49 W
Hydrodynamische efficiëntieklasse (FDEC)	A	Vermogensverbruik in Stand-by modus	0.99 W
Licht Efficiëntie (LE)	34.8 lux/W	Tijdverhogingsfactor (F)	0.7
Licht Efficiëntieklasse (LEC)	A	Energie-efficiëntie Index	41.2
Vetfilter Efficiëntie (GFE)	64.3 %	Gemeten luchtdebiet op het beste efficiëntiepunt (Qbep)	403 m ³ /h
Vetfilter Efficiëntieklasse (GFEC)	E	Gemeten luchtdruk op het beste efficiëntiepunt (Pbep)	479 Pa
Debiet luchtafvoer op minimum snelheid (Qmin)	277 m ³ /h	Gemeten elektrisch vermogen op het beste efficiëntiepunt (Wbep)	148 W
Luchtstroom bij maximale snelheid (Qmax)	636 m ³ /h	Nominaal energieverbruik van de verlichting (WL)	5 W
Luchtstroom bij intensieve snelheid (Qboost)	782 m ³ /h	Gemiddelde verlichting op het kookoppervlak (Emiddle)	139 lux
Akoestische geluidsdruk op minimum snelheid (SPEmin)	50 dB(A)		

Geluidsniveau bij de hoogste instelling (Lwa) 71 dB(A)

Elektrische aansluiting

Nominale aansluitwaarde 279 W
Spanning 220-240 V

Frequentie 50-60 Hz
Lengte voedingskabel 1500 mm

Ook beschikbaar

Andere beschikbare kleuren Zwart

Codes andere beschikbare kleuren KV194B3

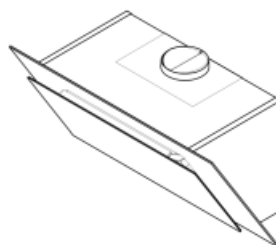
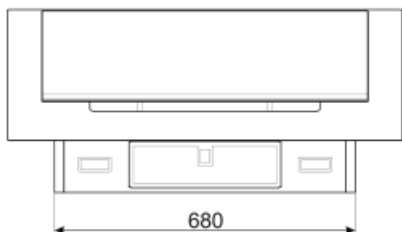
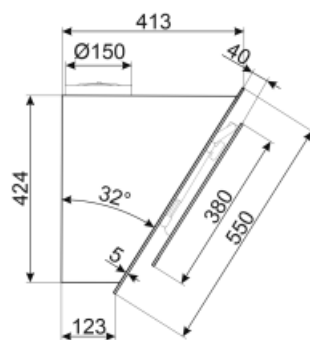
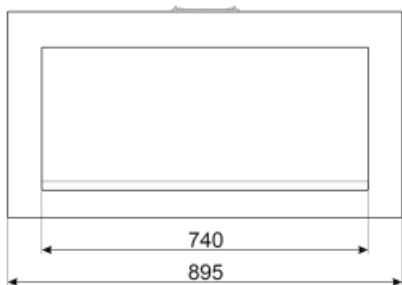

Not included accessories



KITCMNKVX

Chimney Extension in Stainless Steel for hood KV*series 300 mm*200 mm + 500/850 mm



KITALLFC

Universal Charcoal filter Stainless Steel AISI 304 The filter can be washed in dishwasher 50 °C (water and suitable detergent) and to dry it put in the oven 180°C 25 minutes



KITFCKV1













Kit 2 pcs Charcoal Filter for Hood KV1*series. Dishwasher-safe. Size 320x80 mm and 280 x280 mm.



KITCMNKVMB

Chimney Extension in Stainless Steel for hood KV*series 300 mm*200 mm + 500/850 mm

Symbols glossary (TT)

 <p>24h: When selected this function refreshes the air for c. 10 minutes every hour over a 24 hour period, at minimum speed and an imperceptible noise level.</p>	 <p>Filters: Model has filters to help remove grease from the steam emanating from the pans during cooking.</p>
 <p>Automatisch uitschakelen: Een speciale instelling, om na het einde van de bereiding een vooraf ingestelde tijd te laten lopen en daarna automatisch uit te schakelen.</p>	 <p>Charcoal filters: Extracting through charcoal filters or directly to the exterior lessens strong cooking odours considerably.</p>
 <p>Connection between hob and hood</p>	 <p>A+: Energy efficiency class A+ helps to save up to 10% energy compared to class A. Maximum performance with minimum consumption is guaranteed.</p>
 <p>Warning light(s): to advise when filters need changing.</p>	 <p>Lights: All cooker hoods feature lights to illuminate the cooking area or add to the ambience of the kitchen.</p>
 <p>Perimeter extraction panels: very efficient and aid noise reduction.</p>	 <p>Intensive/turbo setting: when extra fast extraction is required.</p>
 <p>Dimmering Lights</p>	 <p>Tunable white from warm to cold</p>