

KV194G







Product family	Hood
Tipo de Exaustor	Decorative wall hood
Design	Angled
Extraction	Extraction
Electronic control	Yes
Perimeter extraction	Yes
Material	Glass
EAN code	8017709327897
Aesthetic	Linea
Colour	Neptune Grey
Acabamento	Glass
Glass Type	Black
Cor da serigrafia	Serigrafia em cinzento
Logotipo	Logotipo serigrafado



Controls

Control setting	Controle de toque retroiluminado Branco	Display	No
Led color	White		

Program / Functions

No. of speeds	3
Intensive speed	
24h air filter function	
Time-setting options	
Other options	No
Ventilação automática	No
Ventilação automática 2.0	

Technical Features



Hood without motor	No	No. of filters	2
Remote motor	No	Anti-grease filters	Stainless steel
No. of lights	2	Charcoal filters included	Yes
Light type	LED	Filter replacement indicator	Yes
Light Power	2.1 W		
Dimmer mode	Yes	Vent outlet	150 mm

Faixa de temperatura de cor clara	2700° - 4000° °K	Minimum distance from GAS hob	650 mm
Free outlet maximum capacity	820 m³/h	Minimum distance from ELECTRIC hob	450 mm
Motor power	275 W	Non return valve	Yes

	Extraction rate IEC 61591 [m³/h]	Noise level IEC 60704-2-13 [dBA]
Speed 1	277	50
Speed 2	406	63
Speed 3	636	70
Intensive speed	782	72

Accessories Included

Remote control	No	Tube reduction	No
Sliding door	No		

Performance / Energy Label



Consumo anual de energia (CAE exaustor)	41 kWh/a	Airborne acoustical A-weighted sound Power Emission at maximum speed (SPEmax)	71 dBA
Energy efficiency class (EEC)	A+	Airbourne acoustical A-weighted sound power emission at boost speed (SPEboost)	72 dBA
Fluid Dynamic Efficiency (FDE)	36,2	Power Consumption in Off mode (Po)	0,49 W
Fluid Dynamic Efficiency class (FDEC)	A	Power consumption in stand-by mode (Ps)	0,99 W
Lighting Efficiency (LE)	34,8 lux/W	Time increase factor (F)	0,7
Lighting Efficiency Class (LEC)	A	Energy Efficiency Index	41,2
Grease Filtering Efficiency (GFE)	64,3 %	Measured air flow rate at best efficiency point (Qbep)	403 m³/h
Grease Filtering Efficiency Class (GFEC)	E	Measured air pressure at best efficiency point (Pbep)	479 Pa
Air flow at minumum speed (Qmin)	277 m³/h	Measured electric power input at best efficiency point (Wbep)	148 W
Air flow at maximum speed (Qmax)	636 m³/h	Nominal Power consumption of the light system (WL)	5 W
Air flow at boost speed (Qboost)	782 m³/h	Average illumination of the light on the cooking surface (Emiddle)	139 lux
Airbourne acoustical A-weighted sound Power Emission at minimum speed (SPEmin)	50 dBA		

Sound power level at highest setting (Lwa) 71 dBA

Electrical Connection

Plug	No	Frequency (Hz)	50-60 Hz
Electrical connection rating	279 W	Comprimento do cabo de alimentação	1500 mm
Voltage	220-240 V		

Also available

Outras cores disponíveis Preta

Códigos das outras cores disponíveis KV194B3

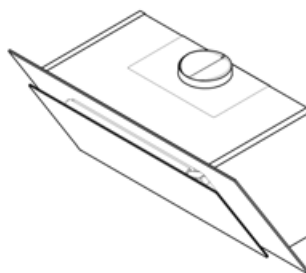
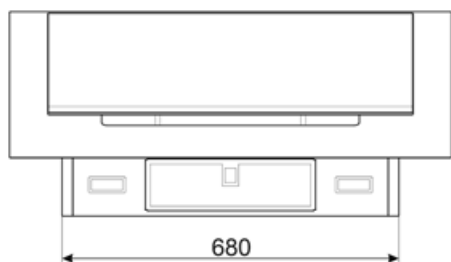
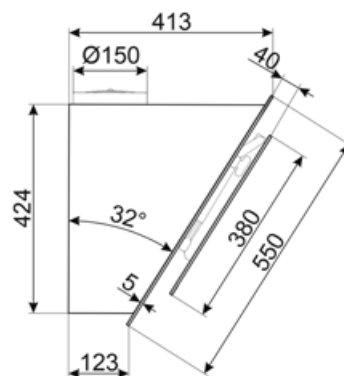
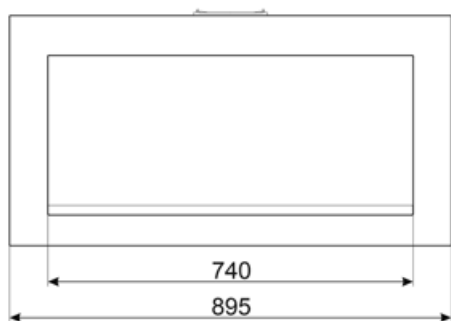

Compatible Accessories



KITALLFC

Filtro de carvão universal Aço inoxidável AISI 304 O filtro pode ser lavado na máquina lava-louça a 50 °C (água e detergente adequado) e para secar colocar no forno 180°C 25 minutos



KITCMNKVX

Extensão da chaminé em aço inoxidável para capuz da série KV*



KITCMNKVMB













Chimney Extension in Stainless Steel for hood KV*series 300 mm*200 mm + 500/850 mm



KITFCKV1

Kit 2 peças Filtro de carvão para a série KV1* do capuz. Pode ser lavado na máquina de lavar louça. Tamanho 320x80 mm e 280 x280 mm.

Symbols glossary

	24h: Quando seleccionada, esta função refresca o ar durante cerca de 10 minutos a cada hora durante um período de 24 horas, a uma velocidade mínima e a um nível de ruído imperceptível.		Filtros: O modelo tem filtros para ajudar a remover a graxa do vapor que emana das panelas durante o cozimento.
	Ligação entre a placa e o exaustor		Desligar automaticamente: Uma configuração especial, para ser executada após o final do cozimento por um tempo pré-definido e, em seguida, desligar automaticamente.
	Filtros de carvão: Extrair através de filtros de carvão ou diretamente para o exterior diminui consideravelmente os fortes odores de cozimento.		A+: A classe de eficiência energética A+ ajuda a economizar até 10% de energia em comparação com a classe A. O desempenho máximo com consumo mínimo é garantido.
	Luz(s) de aviso: para avisar quando os filtros precisam ser trocados.		Luzes: Todos os exaustores possuem luzes para iluminar a área de cozinhar ou adicionar ao ambiente da cozinha.
	Painéis de extração de perímetro: muito eficiente e ajuda na redução de ruído.		Configuração intensiva/turbo: quando a extração extra rápida é necessária.
	Luzes de escurecimento		Branco sintonizável do quente ao frio

Benefit (TT)

Dimmering & Tunable lights

Customized lighting with LED lights featuring adjustable intensity and color temperature, from warm to cool tones

Perimetral aspiration

Optimized extraction through the perimeter aspiration system

Perimeter aspiration enhances extraction efficiency by directing vapors along the edges of the panel beneath the filters, optimizing air capture

Touch display back lighted white

Intuitive and immediate usability thanks to the elegant white LED backlit touch display

Autovent 2.0

Centralized and practical control via Bluetooth connection between hob and hood

The Auto-Vent 2.0 system enables automatic hood management through connection with the hob: both appliances switch on simultaneously, and the extraction power adjusts in real time to the cooking intensity.