

KV28N





Product familie	Dampkap
Type dampkap	Decoratieve muurdampkap
Type dampkap	Verticaal
Extractie	Extractie
Elektronische bediening	Ja
Randafzuiging	Ja
Materiaal	Glas
EAN-code	8017709290603
Breedte dampkap	80 cm
Design	Universeel
Kleur	Zwart
Afwerking	Glas
Type glas	Zwart
Kleur serigrafie	Wit
Logo	Geëtst



Bediening

Bediening	Touch bediening met witte LED	LED kleur	Wit
-----------	-------------------------------	-----------	-----

Program / Functions

Aantal snelheden	3
Snelheid Intensief	
Luchtzuiveringsfunctie (24 uur)	
Automatische uitschakeling	

Technische specificaties



Aantal lampen	2	Aantal filters	2
Type lamp	LED	Vetfilters	Aluminium
Vermogen lamp	1,1 W	Indicator vervangen filter	Ja
Dimmerfunctie	Ja	Diameter ventilatie outlet	150 mm
Temperatuur licht (Kelvin)	4000 K	Minimum afstand van gaskookplaat	650 mm
Capaciteit P0	670 m ³ /h	Minimum afstand van elektrische kookplaat	450 mm
Vermogen motor	230 W		

Terugslagklep

Ja

	Capaciteit niveau 1 (IEC 61591) [m³/h]	Geluidsniveau niveau 1 (IEC 60704-2-13) [dBA]
Snelheid 1	242	44
Snelheid 2	326	51
Snelheid 3	420	58
Snelheid Intensief	666	67

Meegeleverde accessoires



Meegeleverde koolstoffilters Ja

Prestaties / energielabel



Jaarlijkse energieconsumptie (AEC) 49 kWh/jaar

Energie-efficiëntieklasse (EEC) A

Hydrodynamische efficiëntieklasse (FDE) 31,5

Hydrodynamische efficiëntieklasse (FDEC) A

Licht Efficiëntie (LE) 118,6 lux/W

Licht Efficiëntieklasse (LEC) A

Vetfilter Efficiëntie (GFE) 77,0 %

Vetfilter Efficiëntieklasse (GFEC) C

Debiet luchtafvoer op minimum snelheid (Qmin) 242 m³/h

Luchtstroom bij maximale snelheid (Qmax) 420 m³/h

Luchtstroom bij intensieve snelheid (Qboost) 666 m³/h

Akoestische geluidsdruk op minimum snelheid (SPEmin) 44 dBA

Akoestische A-gewogen geluidsemissie op maximum snelheid 58 dBA

Akoestische A-gewogen geluidsvermogens in de lucht met intensieve snelheid 67 dBA

Tijdverhogingsfactor (F) 0,9

Energie-efficiëntie Index 51,1

Gemeten luchtdebiet op het beste efficiëntiepunt (Qbep) 363 m³/h

Gemeten luchtdruk op het beste efficiëntiepunt (Pbep) 453 Pa

Gemeten elektrisch vermogen op het beste efficiëntiepunt (Wbep) 145 W

Nominaal energieverbruik van de verlichting (WL) 2 W

Gemiddelde verlichting op het kookoppervlak (Emiddle) 261 lux

Geluidsniveau bij de hoogste instelling (Lwa) 58 dBA

Elektrische aansluiting

Nominale aansluitwaarde	232 W	Lengte voedingskabel	1500 mm
Spanning	220-240 V	Stekker	Nee
Frequentie	50-60 Hz		

Ook beschikbaar

Andere beschikbare kleuren	Wit, Zilverkleurig glas	Codes andere beschikbare kleuren	KV28S-KV28B
----------------------------	-------------------------	----------------------------------	-------------

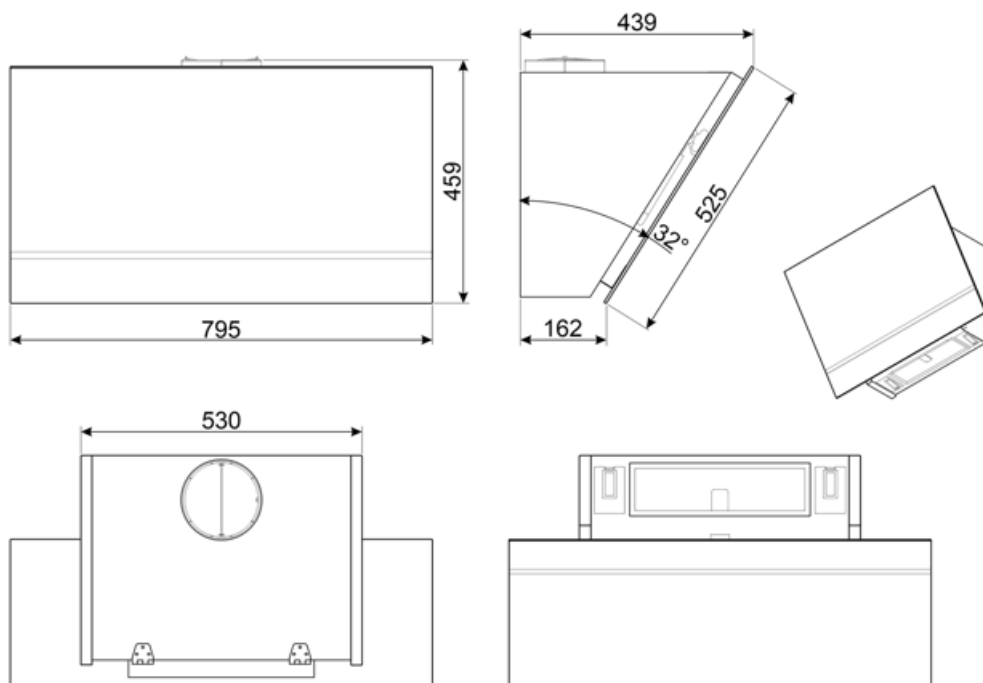

Compatible Accessories



FLT6

Round Charcoal filters (kit 2 pieces)



KITCMNKVMB

Chimney Extension in Stainless Steel for hood KV*series 300 mm*200 mm + 500/850 mm



KITALLFC











Universal Charcoal filter Stainless Steel AISI 304 The filter can be washed in dishwasher 50 °C (water and suitable detergent) and to dry it put in the oven 180°C 25 minutes



KITCMNKVX

Chimney Extension in Stainless Steel for hood KV*series Dimensions 300x200x850 mm

Symbols glossary

	24h: When selected this function refreshes the air for c. 10 minutes every hour over a 24 hour period, at minimum speed and an imperceptible noise level.		Filters: Model has filters to help remove grease from the steam emanating from the pans during cooking.
	Energy efficiency class A		Automatisch uitschakelen: Een speciale instelling, om na het einde van de bereiding een vooraf ingestelde tijd te laten lopen en daarna automatisch uit te schakelen.
	Charcoal filters: Extracting through charcoal filters or directly to the exterior lessens strong cooking odours considerably.		Warning light(s): to advise when filters need changing.
	Lights: All cooker hoods feature lights to illuminate the cooking area or add to the ambience of the kitchen.		Perimeter extraction panels: very efficient and aid noise reduction.
	Intensive/turbo setting: when extra fast extraction is required.		Dimmering Lights