



LBA10N-2

EAN Code	8017709229573
Produktfamilie	Waschmaschine
Komm. Breite	60 cm
Installation	Teilintegrierbar
Beladungstyp	Frontlader



Programme

Bedienungsart	Elektronisch
Programmgrafik	Schriftzug (IT)
Anzahl der Waschprogramme	15
Programme	

- | | | |
|---|---|---|
|  Hemden/Business 40°C |  Baumwolle 40°C |  Baumwolle 60°C |
|  Baumwolle 90°C |  Baumwolle kalt |  Pflegeleicht 20°C |
|  Wolle 30° |  Wolle Kalt |  Mix 30°C |
|  Kurz 15 min/30°C |  Spülen/Schleudern |  Abpumpen/Schleudern |
|  Synthetik 30°C |  Synthetik 40°C |  Synthetik kalt |

Variable Temperaturregelung

Kaltwäsche	30°C	40°C
60°C	90°C	

Sonderprogramme

- | | | |
|--|---|---|
|  Hemden/Business |  Wolle |  Mix |
|  Kurz 15 min. | | |

Displayanzeige

Restzeitanzeige

Zeitvorwahl

Programmstatus

Schleuderleistung

Display



Sonderfunktionen



Zeitvorwahl



Vorwäsche



Extraspülen



Bügelleicht



Schnell



Intensiv

Betriebsanzeige

Ja

Anzeige Programmstatus

Ja

Anzeige Programmende

Ja

Technische Eigenschaften



Motortyp

Standard

Türöffnungswinkel

110°

Elektronische

Ja

Mengenautomatik

Ja

Unwuchtkontrolle

Schaumerkennung

Ja

Programm-

Ja

/Temperaturwahl über
Bedienknebel

Unwuchtkontrolle

Ja

Variable

Schleuderausschluss/ 400/

Flusensieb/Fremdkörperfalle
herausnehmbar

Ja

Schleuderdrehzahl über
Display/Led

500/ 600/ 800/ 1000

Tastensperre/Kindersicherung

Ja

Einspülkammer:

Ja

Kunststoff (PP)

Überlaufschutz

Ja

Trommelmaterial

Edelstahl

Wechselseitiger Türanschlag
der Möbeltür

Ja

Trommelvolumen

52 l

Einsatz für

Ja

Flüssigwaschmittel

Beladungsöffnung Ø

30 cm

Technische Daten / Energielabel - Reg. 2019 - bindend ab 1.3.2021

Name oder

SMEG

Handelsmarke des

Lieferanten

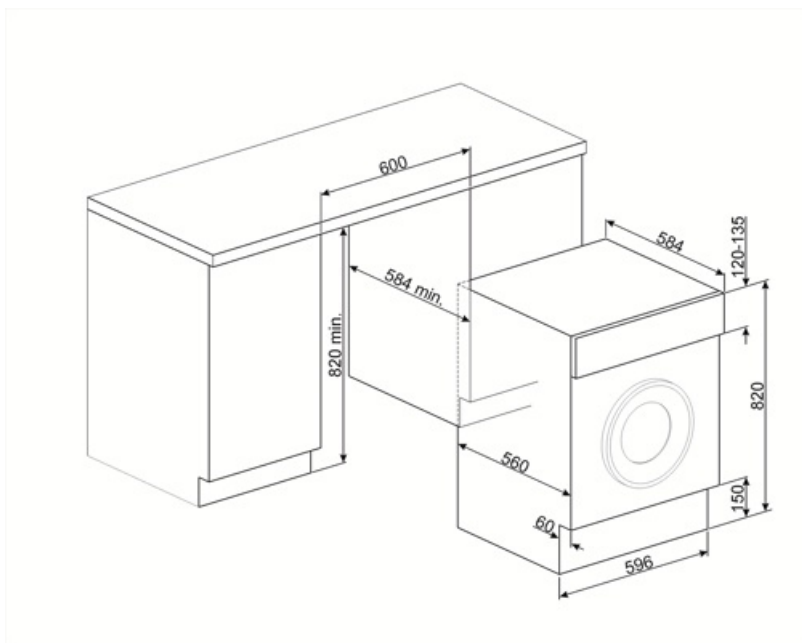

Kompatibel Zubehör



























KITPLV2









Kit 2 m Schlauchverlängerung für
Wasserzu-/Ablauf in 3/4" inkl.
Verbindungszubehör, geeignet für
Geschirrspüler, Waschautomaten und
Vollwaschtrockner



KITWDHE1

Symbols glossary

 <p>Easy Iron: this is an option which can be selected to ensure the finished laundry is left with less creases to make ironing easier.</p>	 <p>Variable load: In all models of washing machines is present the system of variable load, according to which the machine automatically diversifies the wash cycle and the time of operation depending on the quantity and type of laundry introduced, allowing a significant saving of water and energy power, up to 30% compared to the versions with fixed load.</p>
 <p>Automatic Load Balancing: provides an ideal distribution of laundry in the drum. In case if the imbalance is detected, the rotation speed starts being controlled in such way to evenly redistribute laundry in the drum, and thus reduce vibration.</p>	 <p>Kindersicherung: Eine Tastensperre, die einen ungewollten Zugriff auf die Funktionen verhindert.</p>
	 <p>Delay timer: can be set to run the programme at a convenient time or to take advantage of off-peak energy periods.</p>
 <p>LED-Display: zur optischen Anzeige der gewählten Programme, Funktionen und Optionen sowie die Restlaufzeit bis Programmende.</p>	 <p>30 cm: Large loading hatch of 30-32-33 cm in diameter, makes laundry loading and unloading easier and faster with maximum ease of use.</p>
 <p>This option advises when the periodic cleaning of the filters is needed, in order to avoid forgetfulness and thus guarantee the perfect functioning of the dryer over time. The convenient position of the filters makes maintenance fast and extremely simple.</p>	 <p>Intensive: this option intensifies the selected program. Cycle duration and water consumption are reduced by taking into account the type of laundry, while still guaranteeing excellent washing results, even in the case of stains that are difficult to eliminate.</p>
 <p>Prewash: program designed for heavily soiled garments.</p>	 <p>Cotton 40°: For soiled fabrics in cotton</p>
 <p>Cotton 60°: For soiled fabrics in cotton</p>	 <p>Cotton 90°: For soiled fabrics in cotton</p>
 <p>Cotton Cold: For soiled fabrics in cotton</p>	 <p>Delicate 20°: Clothing such as underwear, hosiery and luxury fabrics should be dried on the delicate cycle to help extend the life of the clothing.</p>
 <p>To drain the water in the machine.</p>	 <p>Verlängerte Nachspülung</p>
 <p>Mix 30°: washing program that allows to wash your cotton and synthetic clothes together without sorting them.</p>	 <p>Mixed fabrics: this cycle is designed for lightly soiled laundry in a mix of cottons and synthetics, or can be used just to refresh stored items.</p>
 <p>Rapid 15-30 ° : Rapid washing program at 30 °, let to clean slightly dirty items in a very short time.</p>	 <p>Super fast 15 min: a programme designed to wash small amounts of laundry fast, ideal for washing lightly soiled garments.</p>
 <p>To drain the water into the basket + centrifuge action</p>	 <p>Shirts 40°: a cycle to wash shirts in a short time with the utmost care, using a delicate spin for easy ironing.</p>

-
- | | |
|---|---|
|  Shirts: a cycle to wash shirts in a short time with the utmost care, using a delicate spin for easy ironing. |  Synthetic 30 °: washing program at 30 ° for Synthetics items |
|  Synthetic 40 °: washing program at 30 ° for Synthetics items |  Synthetics: Synthetics washing program is designed for non-cotton items that need a slightly more delicate wash |
|  Wool 30°: this programme for wool or delicate fabrics uses slower rotations of the drum to ensure the utmost care for clothing. |  Wool: this programme for wool or delicate fabrics uses slower rotations of the drum to ensure the utmost care for clothing. |
|  Wool Cold: this programme for wool or delicate fabrics uses slower rotations of the drum to ensure the utmost care for clothing. |  Option that allow to reduce times of the selected program. |
|  Drum has maximum capacity of 7kg of dry laundry. | |