

# LBB14PK-2

|                     |                      |
|---------------------|----------------------|
| EAN Code            | 8017709229566        |
| Familie             | Wasmachine           |
| Commerciële breedte | 60 cm                |
| Commerciële diepte  | Standaard capaciteit |
| Installatie         | Vrijstaand           |
| Type lading         | Voorlader            |



## Programs

### Bediening

Grafische weergave programma's













Aantal programma's

Programma's

Elektronisch

Symbolen





15

|   |   |   |
|---|---|---|
|  Delicaat                 |  Overhemden/ Blouses |  Katoen                  |
|  Cotton ECO               |  Fijne was           |  Jeans                   |
|  Wol                      |  Handwas             |  Gemixed                 |
|  Nachtprogramma           |  Kort/Snel was       |  Spoelen + Centrifugeren |
|  Afpompen + centrifugeren |  Synthetisch         |  Sport                   |

### Wastemperatuur

|      |      |      |
|------|------|------|
| Koud | 30°C | 40°C |
| 60°C | 75°C | 90°C |

### Speciale programma's

|  |   |  |
|--|---|--|
|  Overhemden/ Blouses |  Jeans |  Nachtprogramma |
|  Snel 15 min.        |  Sport |  |

## Display

Weergave resttijd

Instelling Delay timer

weergave aanbevolen belading

Programmavoortgang indicatie

Type display



Toetsen/opties



Delay timer



Familie AS400



Voorwas



Extra spoelen



Niet centrifugeren



Anti-kreuk



Intensief



Koud wassen

Aan/uit indicator

Ja

Programmavoortgang indicator

Op display

Indicator einde cyclus

Op display

## Technische specificaties



|  |  |                               |                         |
|--|--|-------------------------------|-------------------------|
| Type motor   | Standaard                                      | Diameter deur                 | 30 cm                   |
| Functionering met elektronische controle                 | Ja   | Opening deur                  | 110°                    |
| Programmaknop  | Ja   | Variabele automatische lading | Ja                      |
| Centrifuge regeling op display/ LED                      | Niet centrifugeren/ 600/ 800/ 1000/ 1200/ 1400 | Schuimbewaking                | Ja                      |
| Temperatuurregeling op display/ LED                      | Ja   | Balanceringsysteem belading   | Automatisch             |
| Polypropyleen tank                                       | Ja   | Makkelijk te bereiken filter  | Ja                      |
| Korf   | Roestvrij staal                                | Kinderbeveiliging             | Blokkeringsinstellingen |
| Capaciteit trommel                                       | 54 l   | Anti-overloopsysteem          | Ja                      |
| Accessoire voor vloeibare reinigingsmiddelen meegeleverd | Ja   | Acquastop systeem             | Total Aquastop          |

## Performance / Energy Label - Reg. 2019

Supplier's name or trademark      SMEG

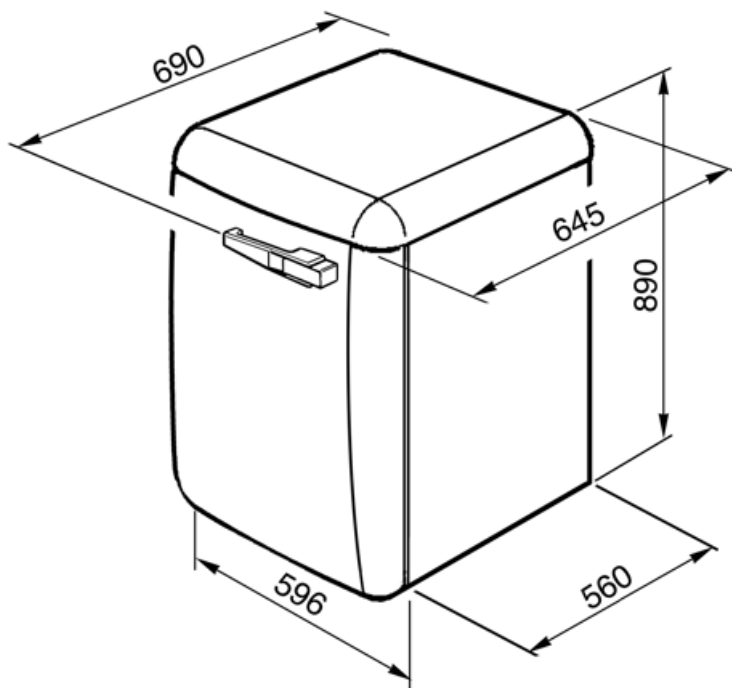

---

## Compatibele Accessoires

















---

















### KITPLV2

Kit verlengstuk voor vaatwasser en wasmachine: lengte 2 mtr.



## Symbols glossary

|  |  |
|--|--|
|  <p><b>Totaal aquastop:</b> De meeste modellen vaatwassers van Smeg zijn uitgerust met Aquastop Totaal, waarmee wateroverlast als gevolg van waterlekage kan worden voorkomen. Het systeem bestaat uit een vlottersensor, geplaatst onder de binnenkamer van een vaatwasser, die de watertoevoer in het apparaat blokkeert in geval van waterlekage in de onderste bak. Een extra elektromagnetische klep op de watertoevoerslang blokkeert ook automatisch de watertoevoer als er waterlekage in de slang wordt gedetecteerd. Voor wasgoed: Totaal aquastop, het product is gebouwd met 3 niveaus van anti-overstromingsapparaten om bescherming tegen waterlekage te garanderen.</p> |  <p><b>Easy Iron:</b> dit is een optie die kan worden geselecteerd om ervoor te zorgen dat het wasgoed minder kreukt en het strijken gemakkelijker wordt</p>  |
|  <p><b>Variable load:</b> In all models of washing machines is present the system of variable load, according to which the machine automatically diversifies the wash cycle and the time of operation depending on the quantity and type of laundry introduced, allowing a significant saving of water and energy power, up to 30% compared to the versions with fixed load.</p>   |  <p><b>Automatic Load Balancing:</b> provides an ideal distribution of laundry in the drum. In case if the imbalance is detected, the rotation speed starts being controlled in such way to evenly redistribute laundry in the drum, and thus reduce vibration.</p> |
|  <p><b>Kinderslot:</b> sommige modellen zijn voorzien van een apparaat om het programma / de cyclus te vergrendelen zodat het niet kan per ongeluk veranderd</p>   |  <p><b>A ++:</b> Energie-efficiëntieklasse A ++ helpt om tot 20% energie te besparen in vergelijking met klasse A. Maximale prestaties bij minimaal verbruik zijn gegarandeerd.</p>   |
|  <p><b>Cold wash</b></p>   |  <p><b>Vertragingstimer:</b> kan worden ingesteld om het programma op een geschikt tijdstip uit te voeren of om te profiteren van energieperiodes buiten de piekuren.</p>   |
|  <p><b>LED-display:</b> toont de geselecteerde programma's, functies en opties en de tijd tot het einde van de cyclus.</p>   |  <p><b>30 cm:</b> Large loading hatch of 30-32-33 cm in diameter, makes laundry loading and unloading easier and faster with maximum ease of use.</p>   |
|  <p>This option advises when the periodic cleaning of the filters is needed, in order to avoid forgetfulness and thus guarantee the perfect functioning of the dryer over time. The convenient position of the filters makes maintenance fast and extremely simple.</p>  |  <p><b>FlexiTime:</b> The FlexiTime option allows the user to reduce the time of the cycle selected, providing extra flexibility and control.</p>   |
|  <p><b>Intensive:</b> this option intensifies the selected program. Cycle duration and water consumption are reduced by taking into account the type of laundry, while still guaranteeing excellent washing results, even in the case of stains that are difficult to eliminate.</p>   |  <p><b>No spin option:</b> this option allows to exclude the last spin phase, draining the water from the tank</p>  |
|  <p><b>Prewash:</b> program designed for heavily soiled garments.</p>  |  <p><b>Cotton:</b> For soiled fabrics in cotton</p>   |

- |  |  |
|--|--|
|  <p>Use to wash your normally soiled, durable cotton and linen laundry. Although it washes longer than all other programmes, it provides high energy and water savings. Actual water temperature may be different from the stated wash temperature. When you load the machine with less laundry (e.g. ½ capacity or less), programme time may automatically get shorter. In this case, energy and water consumption will decrease more, providing a more economic wash. This programme is available in the models with the remaining time indicator.</p> |  <p>Delicate: Clothing such as underwear, hosiery and luxury fabrics should be dried on the delicate cycle to help extend the life of the clothing.</p>   |
|  <p>To drain the water in the machine.</p>   |  <p>Extra Rinse: Extra Rinse: adds an extra rinse cycle to that already provided in the program chosen, to remove any residual detergent. This function is particularly suitable for those with allergies or skin problems.</p> |
|  <p>Hand wash: this specific programme for delicate fabrics uses slower rotations of the drum to ensure the utmost care for clothing.</p>  |  <p>Jeans: a washing cycle which is kind to the colour and fabric of denim whilst minimising wrinkles.</p>  |
|  <p>Mixed fabrics: this cycle is designed for lightly soiled laundry in a mix of cottons and synthetics, or can be used just to refresh stored items.</p>   |  <p>Night: an ideal programme for those who want to take advantage of off-peak energy periods, this cycle is particularly quiet due to slower rotations of the drum.</p>   |
|  <p>Super fast 15 min: a programme designed to wash small amounts of laundry fast, ideal for washing lightly soiled garments.</p>  |  <p>Super fast: a programme designed to wash small amounts of laundry fast, ideal for washing lightly soiled garments.</p>  |
|  <p>To drain the water into the basket + centrifuge action</p>   |  <p>Shirts: a cycle to wash shirts in a short time with the utmost care, using a delicate spin for easy ironing.</p>  |
|  <p>Softener</p>   |  <p>Gym: Gym, a cycle designed for washing lightly soiled garments, ie sports wear, this is a fast wash which is also kind to fabrics.</p>  |
|  <p>Synthetics: to wash your synthetic clothes (shirts, blouses, synthetic/cotton blends, etc.). It washes with a gentle action and has a shorter washing cycle compared to the Cottons programme. For curtains and tulle, use the Synthetic 40°C programme with prewash and anti-creasing functions selected. As their meshed texture causes excessive foaming, wash the veils/tulle by putting little amount of detergent into the main wash compartment. Do not put detergent in the prewash compartment.</p>                                       |  <p>Wool: this programme for wool or delicate fabrics uses slower rotations of the drum to ensure the utmost care for clothing.</p>   |
|  <p>Drum has maximum capacity of 7kg of dry laundry.</p>   |  |