

LBI147

EAN Code 8017709302818
Produktfamilie Waschmaschine
Komm. Breite 60 cm
Installation Vollintegrierbar
Beladungstyp Frontlader



Programme / Funktionen

Bedienungsart Elektronisch
Programmgrafik Symbole
Anzahl der Waschprogramme 15
Programme

 Hemden/Business	 Baumwolle	 Pflegeleicht
Eco 40-60	 Jeans	 Wolle
 Handwäsche	 Mix	 Nacht
Federbett	 Schnell	 Spülen/Schleudern
 Abpumpen/Schleudern	 Synthetik	 Sport

Variable Temperaturregelung

Kaltwäsche	20°C	30°C
40°C	60°C	90°C

Sonderprogramme

 Hemden/Business	 Jeans	 Nacht
 Kurz 15 min.	 Sport	

Displayanzeige

Restzeitanzeige

Zeitvorwahl

Programmstatus

Schleuderleistung

Waschtemperatur

Display



Sonderfunktionen



Zeitvorwahl



FlexiTime



Vorwäsche



Extraspülen



Bügelleicht



Schnell



Intensiv

Betriebsanzeige

Ja

Anzeige Programmstatus

Ja

Anzeige Programmende

Ja

Technische Eigenschaften



Motortyp	Standard	Türöffnungswinkel	110°
Elektronische Unwuchtkontrolle	Ja	Mengenautomatik	Ja
Programmwahl über Bedienknebel	Ja	Schaumerkennung	Ja
Programm-/Temperaturwahl über Bedienknebel	Ja	Unwuchtkontrolle	Ja
Variable Schleuderdrehzahl über Display/Led	Schleuderausschluss/ 600/ 800/ 1000/ 1200/ 1400	Flusensieb/Fremdkörperfalle herausnehmbar	Ja
Einspülkammer: Kunststoff (PP)	Ja	Tastensperre/Kindersicherung	Ja
Trommelmaterial	Edelstahl	Überlaufschutz	Ja
Trommelvolumen	52 l	Stop-Aqua	Ja
Einsatz für Flüssigwaschmittel	Ja	Wasserschutzsystem	
Beladungsöffnung Ø	30 cm	Wechelseitiger Türanschlag der Möbeltür	Ja

Technische Daten / Energielabel - Reg. 2019 - bindend ab 1.3.2021



Name oder Handelsmarke des Lieferanten	SMEG	Schleudereffizienzklasse	B
Nennkapazität in Kilogramm für das Programm "eco 40-60"	7 kg	Luftschallemissionsklasse im Schleudergang	A
		Luftschallemissionen des Schleudergangs in dB(A) re 1 pW	72 dB(A) re 1 pW

Energieeffizienzklasse	E	Programmdauer bei	2:50 h:min
Gewichteter Energieverbrauch pro 100 Betriebszyklen	77 kWh	Nennkapazität	
Gewichteter Wasserverbrauch pro Betriebszyklus in Litern des Programms "eco 40-60"	44 l		

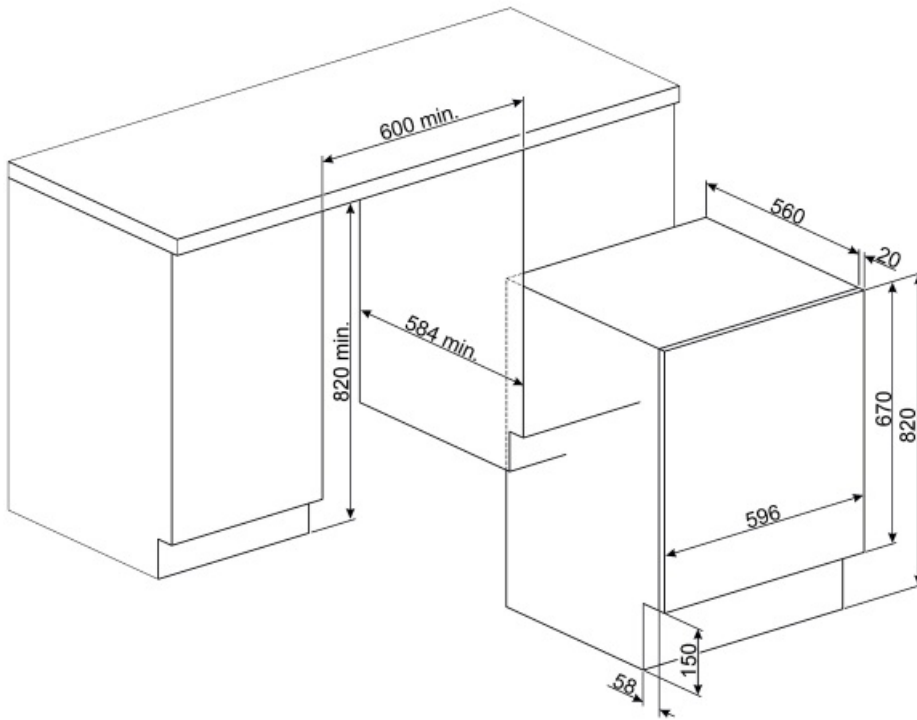

Sonderzubehör



KITWDHE1

















Kit Erhöhung, +50 mm, für vollintegrierbare Waschvollautomaten und Vollwaschtrockner



















KITPLV2

Kit 2 m Schlauchverlängerung für Wasserzu-/Ablauf in 3/4" inkl. Verbindungszubehör, geeignet für Geschirrspüler, Waschautomaten und Vollwaschtrockner

Symbols glossary (TT)

- | | |
|---|--|
|  <p>A++: Die Energieeffizienzklasse A++ ermöglicht eine Energieeinsparung von bis zu 20 % im Vergleich zur Klasse A.</p> |  <p>Total acquastop: Most models of Smeg dishwashers are equipped with Acquastop Totale, which allows to avoid flooding as a result of water leakage. The system consists of a float sensor, disposed under the inner chamber of a dishwasher, which blocks water supply inside the appliance in case of water leakage into the lower tray. An additional electromagnetic valve on the water inlet hose also automatically blocks water supply if detecting water leakage in the hose. For Laundry: Total acquastop, the product is built with 3 levels of anti-flood devices to ensure protection against water leakage. For Laundry: Total acquastop, the product is built with 3 levels of anti-flood devices to ensure protection against water leakage.</p> |
|  <p>Easy Iron: this is an option which can be selected to ensure the finished laundry is left with less creases to make ironing easier.</p> |  <p>Variable load: In all models of washing machines is present the system of variable load, according to which the machine automatically diversifies the wash cycle and the time of operation depending on the quantity and type of laundry introduced, allowing a significant saving of water and energy power, up to 30% compared to the versions with fixed load.</p> |
|  <p>Automatic Load Balancing: provides an ideal distribution of laundry in the drum. In case if the imbalance is detected, the rotation speed starts being controlled in such way to evenly redistribute laundry in the drum, and thus reduce vibration.</p> |  <p>Kindersicherung: Eine Tastensperre, die einen ungewollten Zugriff auf die Funktionen verhindert.</p> |
|  <p>Delay timer: can be set to run the programme at a convenient time or to take advantage of off-peak energy periods.</p> |  <p>LED-Display: zur optischen Anzeige der gewählten Programme, Funktionen und Optionen sowie die Restlaufzeit bis Programmende.</p> |
|  <p>30 cm: Large loading hatch of 30-32-33 cm in diameter, makes laundry loading and unloading easier and faster with maximum ease of use.</p> |  <p>This option advises when the periodic cleaning of the filters is needed, in order to avoid forgetfulness and thus guarantee the perfect functioning of the dryer over time. The convenient position of the filters makes maintenance fast and extremely simple.</p> |
|  <p>FlexiTime: The FlexiTime option allows the user to reduce the time of the cycle selected, providing extra flexibility and control.</p> |  <p>Intensive: this option intensifies the selected program. Cycle duration and water consumption are reduced by taking into account the type of laundry, while still guaranteeing excellent washing results, even in the case of stains that are difficult to eliminate.</p> |
|  <p>Prewash: program designed for heavily soiled garments.</p> |  <p>Cotton: For soiled fabrics in cotton</p> |
|  <p>Delicate: Clothing such as underwear, hosiery and luxury fabrics should be dried on the delicate cycle to help extend the life of the clothing.</p> |  <p>To drain the water in the machine.</p> |

- | | |
|--|--|
|  <p>Extra Rinse: Extra Rinse: adds an extra rinse cycle to that already provided in the program chosen, to remove any residual detergent. This function is particularly suitable for those with allergies or skin problems.</p> |  <p>Hand wash: this specific programme for delicate fabrics uses slower rotations of the drum to ensure the utmost care for clothing.</p> |
|  <p>Jeans: a washing cycle which is kind to the colour and fabric of denim whilst minimising wrinkles.</p> |  <p>Mixed fabrics: this cycle is designed for lightly soiled laundry in a mix of cottons and synthetics, or can be used just to refresh stored items.</p> |
|  <p>PRG NACHT</p> |  <p>Super fast 15 min: a programme designed to wash small amounts of laundry fast, ideal for washing lightly soiled garments.</p> |
|  <p>Super fast: a programme designed to wash small amounts of laundry fast, ideal for washing lightly soiled garments.</p> |  <p>To drain the water into the basket + centrifuge action</p> |
|  <p>Shirts: a cycle to wash shirts in a short time with the utmost care, using a delicate spin for easy ironing.</p> |  <p>Gym: Gym, a cycle designed for washing lightly soiled garments, ie sports wear, this is a fast wash which is also kind to fabrics.</p> |
|  <p>Synthetics: to wash your synthetic clothes (shirts, blouses, synthetic/cotton blends, etc.). It washes with a gentle action and has a shorter washing cycle compared to the Cottons programme. For curtains and tulle, use the Synthetic 40°C programme with prewash and anti-creasing functions selected. As their meshed texture causes excessive foaming, wash the veils/tulle by putting little amount of detergent into the main wash compartment. Do not put detergent in the prewash compartment.</p> |  <p>Wool: this programme for wool or delicate fabrics uses slower rotations of the drum to ensure the utmost care for clothing.</p> |
|  <p>Option that allow to reduce times of the selected program.</p> |  <p>Drum has maximum capacity of 7kg of dry laundry.</p> |
|  <p>Energieeffizienzklasse E</p> |  |