

LDR102-2

Material do lava louça	Aço inox
Tipo de lava louça	Lava louça soldado
Nº de cubas	1 + 3/4
Escorredor	Escorredor reversível
Código EAN	8017709304591



Design



Design	Universal	Instalação	Instalação de perfil baixo sobre a bancada
Design	Série Mira	Logótipo	Logótipo embutido
Cor	Aço inox	Furo para a misturadora	2 furos para misturadora e válvula automática
Acabamentos	scotch Brite		

	Tipologia de cuba	Espessura do aço das cubas	Dimensões da cuba direita, LxPxA	Profundidade da cuba (mm)	Raio angular das cubas	Furo de escoamento de excesso de água	Posição da válvula de escoamento	Diâmetro das válvulas de escoamento
Cuba direita	1/2 cuba	1	147 x 296 x 150	150	50		Válvula de escoamento central	ø 3.5"
Cuba esquerda	Cuba com cantos Radius	1	340 x 400 x 200	200	15	Furo de escoamento de excesso de água plano	Válvula de escoamento lateral	ø 3.5"

Especificações técnicas



Espessura da moldura	0.7 mm	Comando de válvula automática	Comando de válvula automática de duas vias
Profundidade da moldura (mm)	15	Tipo de comando de válvula automática	Comando de válvula automática redondo

Dimensões do produto (mm)	215x1000x500 mm	Largura da divisória das cubas	30 mm
Dimensões do furo para encaixe (mm)	980 x 480 mm	Inclinação do escorredor	2 °
Altura relativamente ao tampo da cozinha	6 mm	Tipo de vedantes	Vedantes de massa
Medida do móvel de encaixe	80 cm	Número de ganchos de fixação	8
Furo para a misturadora	Ventilador duplo	Tipologia de ganchos de fixação	Ganchos standard
Ø do furo da misturadora	35 mm		

Acessórios incluídos

Fornecido com acessórios para instalação

Válvula de escoamento,
Sifão com ligação à máquina de lavar louça,
Ganchos de fixação,
Vedantes, Válvula de abertura automática

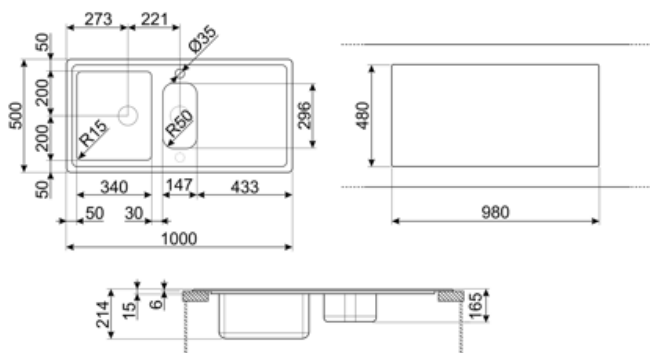

Not included accessories



KITFD050

Waste disposal 0,5 HP, Motor: 1/2 horsepower, Fits all sinks with 3 1/2" waste outlet



DB34

St/steel drain basket to fit STD radius 340 x 400 bowl, 180 mm depth



COL36

St/steel colander for MINIMUM radius bowls, measures 370 x 410 x 30 mm



KITFD100

Waste disposal 1 HP, Motor: 1/2 horsepower, Fits all sinks with 3 1/2" waste outlet



3713

Siphon double bowls sinks (dishwasher connection included)



STABMIX

Tap stabiliser



COL19H

St/Steel colander to fit MINIMUM radius mm bowl, measures 200 x 410 x 100 mm



COL19

St/Steel colander to fit MINIMUM radius mm bowl, measures 200 x 410 x 26 mm



CB25MN

Single HPE chopping board to fit minimum radius bowls, black matt, measures 250 x 410 H 12 mm, dishwasher safe



KITFD075

Waste disposal 0,75 HP, Motor: 1/2 horsepower, Fits all sinks with 3 1/2" waste outlet



KITSLTRND2





2 Bowls automatic Rondò pop up waste kit with rectangular overflow and round knob



CB28QU

Single HPL chopping board for minimum radius, oak, measures 280 x 418 H 12 mm

Symbols glossary (TT)

- | | | | |
|--|---|---|--|
|  | Identifica a largura mínima, em centímetros, necessária no móvel para instalar o lava-louça |  | Altura da cuba: Permite ter uma perceção da capacidade para receber louça. |
|  | Altura da cuba: Permite ter uma perceção da capacidade para receber louça. |  | Lava-louça com instalação superior mas com perfil baixo. |
|  | Thanks to the double tap hole, most of our sinks are easily reversible, giving you the flexibility to make any type of kitchen composition. | | |