

LEH861D

Material do lava louça	Aço inox
Tipo de lava louça	Lava louça soldado
Nº de cubas	1
Escorredor	Escorredor à direita
Código EAN	8017709209179



Design



Design	Universal	Instalação	Instalação de baixo perfil sobre a bancada
Design	Série Rigae	Logótipo	Logótipo embutido
Acabamento	Aço inox	Furo para a misturadora	1 furo para a misturadora
Acabamentos	Escovado		

	Tipologia de cuba	Espessura do aço das cubas	Dimensões da cuba esquerda, LxPxA	Profundidade da cuba (mm)	Raio angular das cubas	Furo de escoamento de excesso de água	Posição da válvula de escoamento	Diâmetro das válvulas de escoamento
Cuba esquerda	Cuba com cantos normais	0.7	340 x 400 x 210	210	80	Furo de escoamento de excesso de água	Válvula de escoamento à parede	ø 3.5"

Especificações técnicas



Espessura da moldura	0.7 mm	Diâmetro do furo da misturadora	35 mm
Profundidade da moldura (mm)	15	Inclinação do escorredor	2 °
Dimensões do produto (mm)	225x860x500 mm	Tipo de vedantes	Vedantes de massa
Dimensões do furo para encaixe (mm)	840 x 480 mm	Número de ganchos de fixação	6
Altura relativamente ao tampo da cozinha	6 mm	Tipologia de ganchos de fixação	Ganchos standard

Medida do móvel de encastre 45 cm







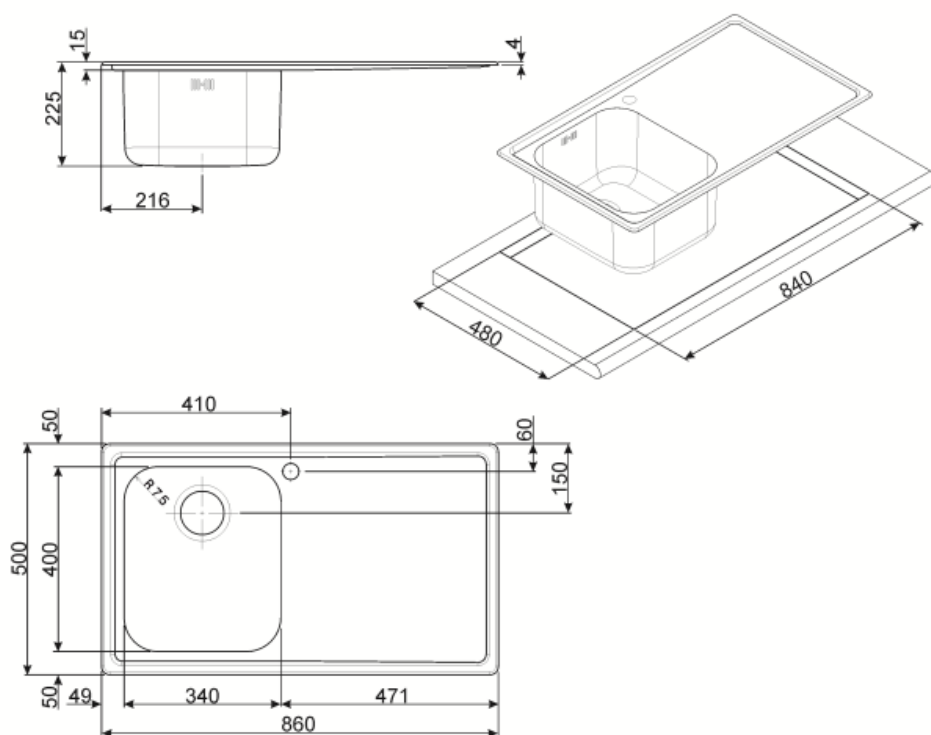





Acessórios incluídos

Fornecido com acessórios para instalação

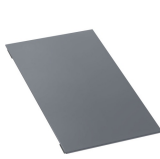

Válvula de escoamento,
Sifão com ligação à máquina de lavar louça,
Ganchos de fixação,
Vedantes

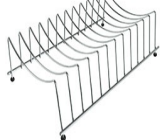

Not included accessories

	<p>KITW2 Plug standard waste kit</p>		<p>RND1V Rondò waste kit 1 bowl with standard overflow</p>
	<p>KITFD050 Waste disposal 0,5 HP, Motor: 1/2 horsepower, Fits all sinks with 3 1/2" waste outlet</p>		<p>DB34 St/steel drain basket to fit STD radius 340 x 400 bowl, 180 mm depth</p>
	<p>KITFD100 Waste disposal 1 HP, Motor: 1/2 horsepower, Fits all sinks with 3 1/2" waste outlet</p>		<p>MATROL Stainless steel drainer 405 x 340 mm</p>
	<p>STABMIX Tap stabiliser</p>		<p>TVS2 Silver sliding glass chopping board Siver color Black Linea width 240 mm Stainless Steel under glass</p>
	<p>CB34 Single wooden chopping board to fit STD radius 340 x 400 mm bowl</p>		<p>KITFD075UK Waste disposal 0,75 HP, Motor: 1/2 horsepower, Fits all sinks with 3 1/2" waste outlet, UK</p>
	<p>KITFD075 Waste disposal 0,75 HP, Motor: 1/2 horsepower, Fits all sinks with 3 1/2" waste outlet</p>		<p>KITFD050UK Waste disposal 0,5 HP, Motor: 1/2 horsepower, Fits all sinks with 3 1/2" waste outlet, UK</p>
	<p>KITFD100UK Waste disposal 1 HP, Motor: 1/2 horsepower, Fits all sinks with 3 1/2" waste outlet, UK</p>		<p>COLPTX Draining rack base 300 x 185 x 82 mm</p>

Symbols glossary (TT)

- | | | | |
|--|---|---|--|
|  | Identifica a largura mínima, em centímetros, necessária no móvel para instalar o lava-louça |  | Altura da cuba: Permite ter uma perceção da capacidade para receber louça. |
|  | Lava-louça com instalação superior mas com perfil baixo. | | |