

# LFT34RS

**Sink material** Stainless steel  
**Type** Welded bowl  
**No. of bowls** 1  
**EAN code** 8017709210328



## Aesthetics



<b>Aesthetic</b>	Universale	<b>Building in type</b>	Flush fitted, Flat
<b>Colour</b>	Stainless steel	<b>Logo</b>	Embossed
<b>Finishing</b>	Brushed	<b>Tap hole / precut tap hole</b>	2 Tapholes
<b>Series</b>	Mira		

	Bowl type	Bowl dimensions, WxDxH (mm)	Bowl depth (mm)	Radius corner bowl	Overflow	Strainer position	Strainer dimension
Bowl	Minimum radius	340 x 400 x 200	200	15	Yes, flush fitted	Wall position	3.5"

## Technical Features



<b>Dimensions of the product (mm)</b>	200x402x510 mm	<b>Tap hole diameter</b>	35 mm
<b>Cutout dimension topmount (mm)</b>	370 x 490 mm	<b>Popup command</b>	Yes, single
<b>Height from kitchen top</b>	1 mm	<b>Popup command type</b>	Squared
<b>Base unit size</b>	45 cm	<b>No. of clips</b>	8
<b>Tap hole</b>	2	<b>Type of clips</b>	Standard

## Accessories included

Accessories for  
installation

Strainer, Savespace siphon  
with dishwasher outlet  
connection, Fixing clips,  
Gasket, Automatic pop - up  
with roudn rotary control

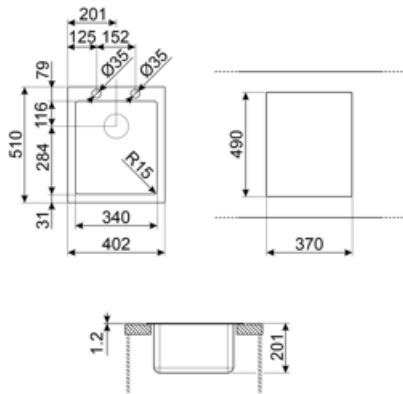

## Compatible Accessories



**3712**

Siphon single bowl sinks (dishwasher connection included)



**CB28QU**

Single HPL chopping board for minimum radius, oak, measures 280 x 418 H 12 mm



**COL19H**

St/Steel colander to fit MINIMUM radius mm bowl, measures 200 x 410 x 100 mm



**DB34**

St/steel drain basket to fit STD radius 340 x 400 bowl, 180 mm depth



**KITFD075**

Waste disposal 0,75 HP, Motor: 1/2 horsepower, Fits all sinks with 3 1/2" waste outlet



**KITSLTRND1**

Bowl automatic pop up Rondò waste kit with rectangular overflow and round knob



**CB25MN**

Single HPE chopping board to fit minimum radius bowls, black matt, measures 250 x 410 H 12 mm, dishwasher safe



**COL19**

St/Steel colander to fit MINIMUM radius mm bowl, measures 200 x 410 x 26 mm



**COL36**

St/steel colander for MINIMUM radius bowls, measures 370 x 410 x 30 mm



**KITFD050**

Waste disposal 0,5 HP, Motor: 1/2 horsepower, Fits all sinks with 3 1/2" waste outlet



**KITFD100**

Waste disposal 1 HP, Motor: 1/2 horsepower, Fits all sinks with 3 1/2" waste outlet







**STABMIX**

Tap stabiliser

---

## Symbols glossary

---

- |  |  |   |   |
|--|--|---|---|
|  | Cupboard width required for sink installation. |  | Sink depth - depending on the model, the depth can be from 13 to 24,5.  |
|  | Flat: Installation of product with flat edge.  |  | Flush-fitted installation: Models of sinks/hobs which are integrated flush with the tabletop of a kitchen unit. |

## Benefit (TT)

---

### **One bowl**

A single bowl for greater adaptability, capacity and space optimisation

### **Double tap hole**

The sink is easily reversible, making it possible to create any type of kitchen composition

### **Pop-up command**

The pop-up command allows the sink drain to be opened and closed remotely with a simple gesture and without the need to touch the plug directly, increasing convenience and hygiene in the kitchen

### **Tap hole**

Possibility of having the tap hole for direct installation of the tap on the sink, for a larger and neater surface area