

LR861

Material del fregadero
Tipología
Número de cubetas
Escurreidor
Código EAN

Acero inoxidable
Soldado
1
Reversible
8017709138806



Estética



Estética	Universal	Tipo de instalación	Filotop, Plato
Serie	Quadra	Logo	Serigrafiado
Color	Acero inoxidable	Agujero para grifo / Agujero para grifo precortado	2 agujeros
Acabado	Satinado		

	Tipología cubeta	Espesor acero cubeta (mm)	Dimensiones cubeta , L x P x A (mm)	Profundidad cubeta (mm)	Radio angular cubeta	Rebosadero cubeta	Posición descarga cubeta	Dimensión descarga cubeta
Cubeta der	Rayada	1	340x450x200	200	10	Sí, tradicional	Lateral cubeta	3.5"

Características técnicas



Espeor almacenamiento	1 mm	Orificio mezclador	1
Profundidad almacenamiento (mm)	5	Mando tapón emergente	Sí, una vía
Dimensiones del producto (mm)	200x864x504 mm	Tipo de mando con interruptor automático	Redondeado
Dimensiones hueco instalación sobre encimera (mm)	844 X 484 mm	Inclinación superficie de escurrimiento	2 °
		Tipo de junta	Sellador
		Número de ganchos	8
		Tipología ganchos	Estándar

Radio angular orificio de 15 mm
empotrado

Altura desde encimera
de la cocina 1 mm

Medida mueble
empotrable 60 cm

Equipo accesorios incluidos

Equipo accesorios
montaje

Cubeta, Sifón con conexión
para lavavajillas, Ganchos
montaje, Junta, Automatic
pop - up with roudn rotary
control

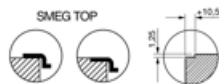
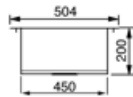
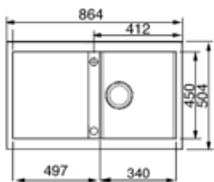
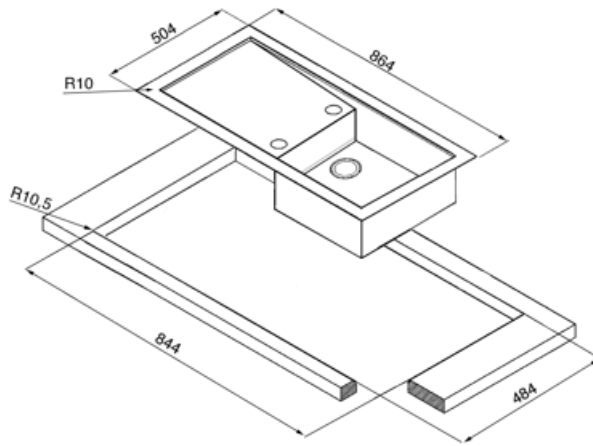





Accesorios Compatible



STABMIX
Tap stabiliser

Symbols glossary

- | | | | |
|--|---|---|---|
|  | Tamaño del mueble base: Se requiere el tamaño del gabinete base para la instalación del fregadero. |  | Indica la profundidad de la cubeta del fregadero |
|  | Plano: modo de instalación del fregadero con borde plano que descansa discretamente sobre la encimera. |  | Filotop: tipo de instalación que permite que la parte superior y el fregadero se integren perfectamente con la parte superior de la cocina. |
|  | Thanks to the double tap hole, most of our sinks are easily reversible, giving you the flexibility to make any type of kitchen composition. | | |

Benefit (TT)

One bowl

A single bowl for greater adaptability, capacity and space optimisation

Drainer

The drawer allows dishes, cutlery and kitchen utensils to be placed directly on the sink after washing: excess water can drain into the sink, allowing for natural drying

Pop-up command

The pop-up command allows the sink drain to be opened and closed remotely with a simple gesture and without the need to touch the plug directly, increasing convenience and hygiene in the kitchen

Tap hole

Possibility of having the tap hole for direct installation of the tap on the sink, for a larger and neater surface area