

# LS13N-4

Product Family	Dishwashers
Width	60 cm
Commercial height	85 cm
Installation	Free-standing
N° baskets	2
EAN code	8017709261047



## Programmes



No. of programmes	5+5 quick programmes	<b>Ultraclean</b>	Yes
Washing temperatures	38, 45, 50, 55, 65, 70 °C	<b>Daily 1/2 load</b>	Yes
Soak	Yes	<b>ECO Quick</b>	Yes
Rapid 27'	Yes	<b>Delicate and Quick</b>	Yes
Glass	Yes	<b>Normal Quick</b>	Yes
ECO	Yes	<b>Strong and fast</b>	Yes

## Options



<b>Delay timer option</b>	3-6-9 hours, with automatic soak	<b>Quick Time option</b>	Yes
---------------------------	----------------------------------	--------------------------	-----

## Baskets



<b>Basket colour</b>	Grey	<b>Lower Basket</b>	With 2 foldable racks
<b>Basket components colour</b>	Grey	<b>Lower basket with anti-drip inserts</b>	Yes
<b>Handle</b>	In plastic on upper and lower basket	<b>Largest loadable dish in lower basket</b>	30,0 cm
<b>Upper Basket</b>	With central fixed racks		
<b>Height adjustment of the upper basket</b>	On three levels		

**Largest loadable dish in upper basket** 23,5 cm

**Colour Inner Components**

Pastel Blue anti drop inserts, Pastel Blue handles, Pastel Blue plate for regulation second basket on three levels, Pastel Blue Orbital

**Cutlery basket**

13 place settings sliding

## Technical Features



<b>Width (mm)</b>	598 mm
<b>Depth (mm)</b>	600 mm
<b>Product Height (mm)</b>	848 mm
<b>Controls</b>	Electronic
<b>Programme graphics</b>	Symbols
<b>Salt light indicator</b>	Light
<b>Rinse aid indicator</b>	Light
<b>Progress indicator</b>	Yes
<b>End of cycle indicator</b>	Acoustic signal
<b>Washing system</b>	Orbital
<b>Third spray arm</b>	Single
<b>Water softener</b>	With electronic setting
<b>Flood protection system</b>	Single Acquastop

**Water supply**

Single; cold/hot water max. 60°C - energysave with hot water up to 35%

**Max water hardness**

100°FH;58°dH

**Drying system**

Natural condenser drying

**Tank material**

Stainless steel

**Filter**

Stainless steel

**Concealed heating element**

Yes

**Hinges**

Self balancing with fixed hinges

**Adjustable feet**

Just for levelling

**Back cover**

Yes, with covered counterweight

**Depth of dishwasher with open door (mm)**

1168

**Removable top**

Yes, with optional KIT

**Top cover**

In plastic

## Electrical Connection

<b>Plug</b>	(F;E) Schuko
<b>Connected power</b>	1800 W
<b>Current</b>	10 A
<b>Voltage</b>	220-240 V

**Frequency (Hz)**

50 Hz

**Type of connection**

Single-phase

**Power supply cable length**

140 cm

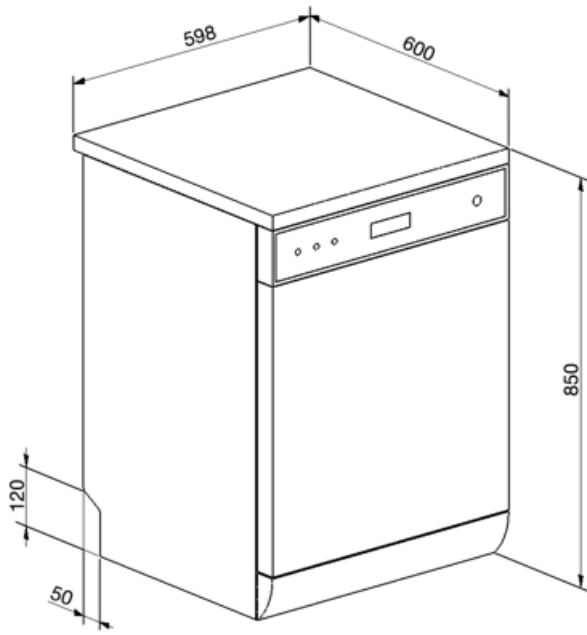

---

## Not included accessories

---

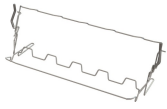

### KITGH

Kit glass holder. It has to be fitted on the first basket but only if there are foldable racks

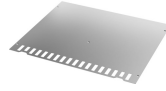

### KITINC















a steel bar fitted on the top will block the dishwasher at the top.



### KITPLV2

Kit extension for dishwasher and washing machine: length mt. 2

## Symbols glossary

 <p>A+: Energy efficiency class A+ helps to save up to 10% energy compared to class A. Maximum performance with minimum consumption is guaranteed.</p>	 <p>Acquastop: Some Smeg dishwashers are equipped with a simple Acquastop: float sensor in the bottom which is necessary to prevent an accidental leakage of water inside the appliance.</p>
 <p>Anti-drip: Some models of dishwashers are equipped with special polymer nozzles anti-drip, that improve the process of drying.</p>	 <p>Delay Timer: The delay timer can postpone the start of the program by up to 24 hours.</p>
 <p>Noise Level: Excellent insulation and special devices keep noise to a minimum.</p>	 <p>Orbital wash system distributes water evenly throughout the 60cm dishwasher cavity, directing water with precision to ensure an excellent wash.</p>
 <p>1/2 load: This program is designed for washing dishes not heavily soiled with partial load of the dishwasher.</p>	 <p>Delicate Quick: Program Delicate Quick is suitable for quick washing of delicate dishes.</p>
 <p>Eco: Eco, this economic wash programme uses a low amount of water and energy in order to provide the most environmentally friendly cleaning option.</p>	 <p>Eco: Eco, this economic wash programme uses a low amount of water and energy in order to provide the most environmentally friendly cleaning option.</p>
 <p>Normal Quick: Program Normal Quick is suitable for quick washing of mixed dishes, for everyday use.</p>	 <p>Soak programme: The soak programme provides a rinse to prevent dirt from drying.</p>
 <p>Strong&amp;Fast: This special programme takes less than 1 hour to eliminate the most stubborn dirt and dried on residues.</p>	 <p>The symbols show the number of plate settings of the dishwasher.</p>
 <p>System WaterSave ensures the best washing results with minimal water consumption depending on the model of dishwasher.</p>	