

LS13N-4

Familie	Vaatwasser
Commerciële breedte	60 cm
Nishoogte	85 cm
Installatie	Vrijstaand
Aantal korven	2
EAN-code	8017709261047

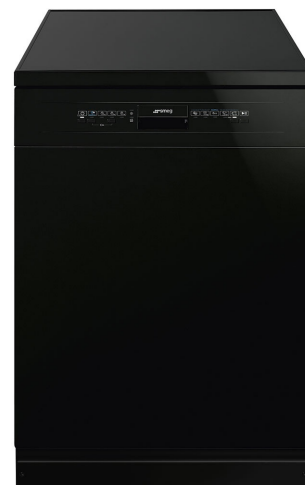

Programs



Aantal programma's	5 standaard + 4 Quick Time programma's	Ultraclean	Ja
Wastemperatuur	38, 45, 50, 55, 65, 70 °C	Dagelijks ½ lading	Ja
Weken	Ja	ECO Quick	Ja
Snel 27'	Ja	Delicate vaat, snel	Ja
Glas	Ja	Normaal snel	Ja
Eco	Ja	Sterk en snel	Ja

Opties



Delay timer optie	3-6-9 uur, i.c.m. automatisch spoelen	Quick Time option	Ja
-------------------	---------------------------------------	-------------------	----

Korven



Kleur korven	Grijs	Onderkorf	2 inklapbare rekken
Kleur korfcomponenten	Grijs	Onderkorf met anti-drup inserts	Ja
Handgreep	Op onder- en bovenkorf	Maximum afmetingen bord dat in onderste korf kan worden geladen	30,0 cm
Bovenkorf	Met vaste rekken		
In hoogte verstelbare bovenkorf	3 niveaus		

Maximum afmetingen bord dat in bovenste korf kan worden geladen	23,5 cm	Kleur binnenonderdelen	Pastel Blue anti drop inserts, Pastel Blue handles, Pastel Blue plate for regulation second basket on three levels, Pastel Blue Orbital
		Bestekmandje	13 couverts, schuivend

Technische specificaties



Breedte product	598 mm	Watertoevoer	Enkel; koud en warm water tot 60°C - energiebesparing tot 35%
Diepte product	600 mm	Maximale waterhardheid	100°FH;58°dH
Hoogte product	848 mm	Droogstelsysteem	Natuurlijke condensatie
Bediening	Elektronisch	Materiaal kuip	Roestvrij staal
Grafische weergave programma's	Symbolen	Filter	Roestvrij staal
Zout indicator	Indicator (lampje)	Verborgen verwarmingselement	Ja
Glansspoelmiddel indicator	Indicator (lampje)	Scharnieren	Zelfbalancerend met vast steunpunt
Indicator voortgang programma	Ja	Verstelbare voetjes	Alleen voor niveau aanpassing
Indicator einde cyclus	Akoestisch signaal	Back cover	Yes, with covered counterweight
Wassysteem	Orbital	Diepte vaatwasser met open deur (mm)	1168
Derde sproeiarm	Enkel	Verwijderbare bovenkant	Ja, met optionele KIT
Waterontkalker	Elektronisch instelbaar	Bovenbedekking	Van kunststof
Overstroombeveiliging	Single Acquastop		

Elektrische aansluiting

Stekker	(F;E) Schuko	Frequentie	50 Hz
Aansluitwaarde	1800 W	Type aansluiting	Single-phase
Stroom	10 A	Lengte voedingskabel	140 cm
Spanning	220-240 V		

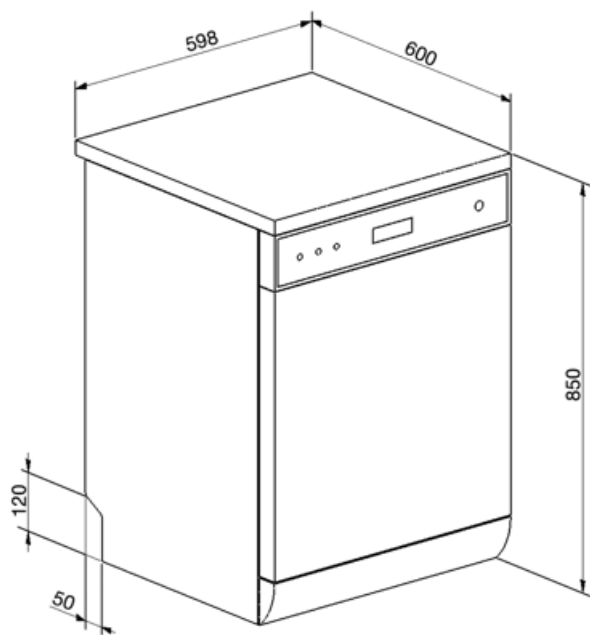

Accessoires niet inbegrepen

KITGH

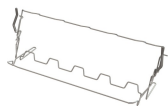

Kit glazen houder. Deze moet op de eerste mand worden gemonteerd, maar alleen als er inklapbare rekken zijn

KITPLV2







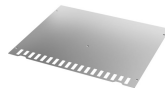









Kit verlengstuk voor vaatwasser en wasmachine: lengte 2 mtr.

KITINC



Symbols glossary (TT)

 <p>A +: Energie-efficiëntieklasse A + helpt om tot 10% energie te besparen in vergelijking met klasse A. Maximale prestaties bij minimaal verbruik zijn gegarandeerd.</p>	 <p>Aquastop: Sommige vaatwassers van Smeg zijn uitgerust met een eenvoudige Aquastop: vlottersensor in de bodem die nodig is om te voorkomen dat er per ongeluk water in het apparaat lekt.</p>
 <p>To improve the drying of dishes without leaving stains.</p>	 <p>Vertragingstimer: De uitgestelde timer kan de start van het programma tot 24 uur uitstellen.</p>
 <p>Noise Level: Excellent insulation and special devices keep noise to a minimum.</p>	 <p>Orbital wash system distributes water evenly throughout the 60cm dishwasher cavity, directing water with precision to ensure an excellent wash.</p>
 <p>1/2 load: This program is designed for washing dishes not heavily soiled with partial load of the dishwasher.</p>	 <p>Delicate Quick: Program Delicate Quick is suitable for quick washing of delicate dishes.</p>
 <p>Eco: Eco, this economic wash programme uses a low amount of water and energy in order to provide the most environmentally friendly cleaning option.</p>	 <p>Eco: Eco, this economic wash programme uses a low amount of water and energy in order to provide the most environmentally friendly cleaning option.</p>
 <p>Normal Quick: Program Normal Quick is suitable for quick washing of mixed dishes, for everyday use.</p>	 <p>Soak programme: The soak programme provides a rinse to prevent dirt from drying.</p>
 <p>Strong&Fast: This special programme takes less than 1 hour to eliminate the most stubborn dirt and dried on residues.</p>	 <p>13 place settings: Number of place settings.</p>
 <p>System WaterSave ensures the best washing results with minimal water consumption depending on the model of dishwasher.</p>	