

LSEG860A2

Sink material	Composite
Type	Composite bowl
No. of bowls	1
EAN code	8017709274764



Aesthetics

	Aesthetic	Universale	Logo	On overflow
	Colour	Anthracite	Alternative colours available	Cream, Beige, Copper
	Series	Classica	Tap hole / precut tap hole	Prepared
	Building in type	Standard		

	Bowl type RH	Bowl dimensions, WxDxH (mm)	Bowl depth (mm)	Radius corner right bowl (mm)	Overflow	Strainer position	Strainer dimension
RH Bowl	Traditional	780 x 370 x 235	235	50	Yes, traditional	Side bowl	3.5"

Technical Features



Characteristics composite material	Antibacterial, Easy to clean, Anti-scratch, Thermal shock resistant, High temperatures resistant, Impact resistant, UV Resistant	Base unit size	90 cm
		Tap hole	2
		Tap hole diameter	35 mm
		No. of clips	8
		Type of clips	Standard
Frame depth (mm)	5		
Dimensions of the product (mm)	240x860x500 mm		

Cutout dimension topmount (mm)	840 x 480 mm
Undermount cutout radius	15 mm
Height from kitchen top	10 mm

Accessories included

Accessories for installation	Strainer, Savespace siphon with dishwasher outlet connection, Fixing clips
---------------------------------	--

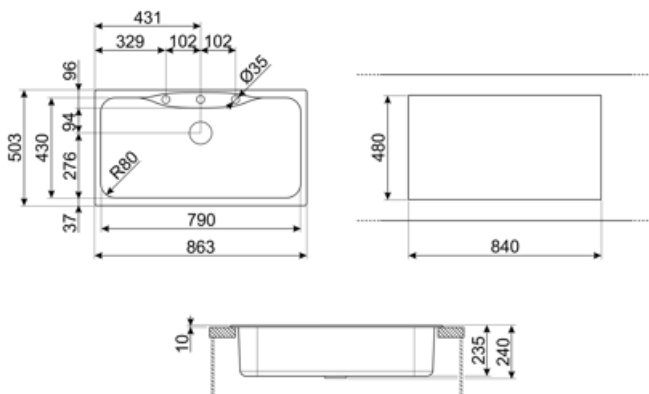

Compatible Accessories



KITDSQ

Soap dispenser chrome finishing with square knob 40x40 mm



KITFD075

Waste disposal 0,75 HP, Motor: 1/2 horsepower, Fits all sinks with 3 1/2" waste outlet



KITFD050

Waste disposal 0,5 HP, Motor: 1/2 horsepower, Fits all sinks with 3 1/2" waste outlet



KITFD100

Waste disposal 1 HP, Motor: 1/2 horsepower, Fits all sinks with 3 1/2" waste outlet

Alternative products

LSEG860AV2

Colour: Oats













LSEG860P

Colour: Cream



Symbols glossary

	Antibacterial		Antiscratch
	Cupboard width required for sink installation.		Sink depth - depending on the model, the depth can be from 13 to 24,5.
	Standard installation: Traditional installation in tabletop, suitable for any kitchen sets.		Thermal shock resistant
	High temperatures resistant		Impact resistant
	Easy to clean		UV protection, does not fade over time.