

LSP382CX



Product Family	Dishwashers
Commercial width	60 cm
Commercial height	82 cm
Installation	Under counter built-in
N° baskets	3, Flexi
Motor	Inverter 2.0
EAN code	8017709307332



Programme / Functions



N. of programmes	5	Mix	Yes
Washing temperatures	50, 65, 70 °C	Intense	Yes
Soak	Yes	1/2 load	Yes
ECO	Yes		

Options



Delay timer option	3-6-9 hours	Extra dry option	Yes
---------------------------	-------------	-------------------------	-----

Baskets



Basket colour	Grey	Largest loadable dish in upper basket	19,0 cm
Basket components colour	Grey	Lower Basket	With 2 foldable racks
Handle	In plastic on upper and lower basket	Lower basket with anti-drip inserts	Yes
Upper Basket	With central fixed racks	Largest loadable dish in lower basket	30,0 cm
Glass holder	Yes	Colour Inner Components	Green
Height adjustment of the upper basket	On three levels (5 cm)		

Technical Features



Width (mm)	598 mm	Max water hardness	100°fH;58°dH
Depth (mm)	570 mm	Drying system	Natural condenser drying, with Dry Assist + automatic door opening system at the end of the cycle
Product Height (mm)	818 mm	Steam protection	In plastic
Controls	Electronic	Tube material	Stainless steel
Programme graphics	Symbols	Filter	Stainless steel
On/off indicator	Yes	Concealed heating element	Yes
Salt light indicator	Light	Hinges	Self balancing with fixed hinges
Rinse aid indicator	Light	Min. and max plinth height	100 - 170 mm
End of cycle indicator	Led on display, with acoustic signal	Adjustable feet	7cm, from 820 to 890 mm
Washing system	Orbital	Back cover	Yes
Third spray arm	Single	Depth of dishwasher with open door (mm)	1146
Water softener	With electronic setting	Back feet adjustable from front	Yes
Flood protection system	Total Acquastop	Top cover	In plastic
Water supply	Single; cold/hot water max. 60°C - energysave with hot water up to 35%		

Performance / Energy Label NEW 2019



Energy Efficiency Class	C	Programme duration	4:10 h:min
Energy consumption [per 100 cycles, based on the eco programme]	73 kWh	Airborne acoustical noise emissions	48 dB(A) re 1 pW
Rated capacity (ps)	13	Airborne acoustical noise emission class	C
Water consumption [per cycle]	12,0 litres	Energy efficiency Index (EEI)	43,8

Electrical Connection

Plug	(F;E) Schuko	Frequency (Hz)	50 Hz
Connected power	1800 W	Type of connection	Single-phase
Current	10 A	Power supply cable length	140 cm
Voltage	220-240 V		

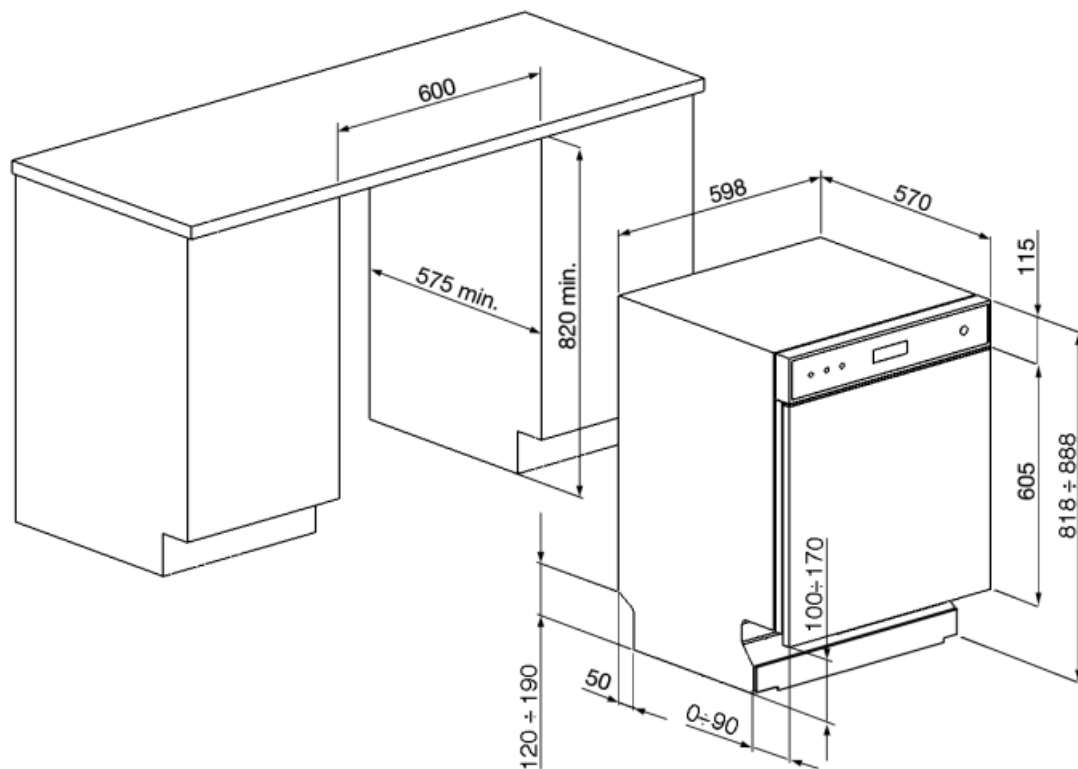

Not included accessories

KITPL60FABB



Toe kick Kit in White colour with adjustable height. Can be fitted over all the fully integrated and underbench models with Fixed Fulcrum. Can be installed also on the models with variable fulcrum or flexifit hinges.

KITPL60FABN



Toe kick Kit in Black colour with adjustable height. Can be fitted over all the fully integrated and underbench models with Fixed Fulcrum. Can be installed also on the models with variable fulcrum or flexifit hinges.

KITGH

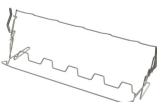

Kit glass holder. It has to be fitted on the first basket but only if there are foldable racks

KITPL60FABX

















Toe kick Kit in Stainless Steel with adjustable height. Can be fitted over all the fully integrated and underbench models with Fixed Fulcrum. Can be installed also on the models with variable fulcrum or flexifit hinges.

KITPLV2



Kit extension for dishwasher and washing machine: lenght mt. 2

Symbols glossary (TT)

 To improve the drying of dishes without leaving stains.	 Energy efficiency class C
 82 cm high	 Delay Timer: Option to postpone the start of the desired programme by up to 24 hours in order to programme the dishwasher to run at the desired time.
 The work aimed at continuous improvement has allowed the creation of the second generation of the Inverter motor 2.0, characterised by greater efficiency and durability over time, which allows very high performance and a lower energy consumption and noise level.	 Noise Level: Excellent insulation and special devices keep noise to a minimum.
 EXTRA DRY This option adds a hot rinse cycle that ensures improved drying.	 Orbital wash system distributes water evenly throughout the 60cm dishwasher cavity, directing water with precision to ensure an excellent wash.
 1/2 load: This program is designed for washing dishes not heavily soiled with partial load of the dishwasher.	 Eco: Eco, this economic wash programme uses a low amount of water and energy in order to provide the most environmentally friendly cleaning option.
 Mix: The Mix programme is suitable for mixed crockery and everyday pots and pans, without any particular incrustation.	 Soak programme: The soak programme provides a rinse to prevent dirt from drying.
 Ultraclean: The Ultraclean option performs a final rinse at a high temperature of 70°C eliminating virtually all bacteria.	 13 place settings: Number of place settings.
 Total Acquastop: In addition to the partial Acquastop protection present in all Smeg dishwashers, some models have an electronic device fitted to the water intake hose, which monitors water levels in the machine, detects leaks in the hose and switches off the water supply immediately when necessary.	 System WaterSave ensures the best washing results with minimal water consumption depending on the model of dishwasher.