

LSPU8612S

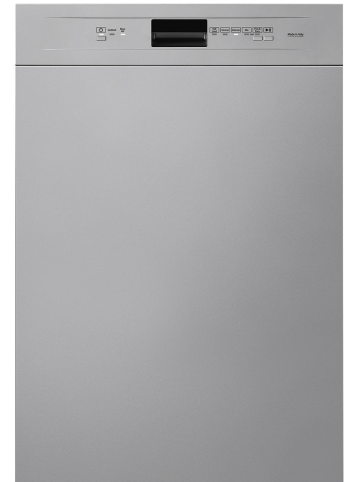

Product family	Dishwashers
Width	24"
Commercial height	86 cm
Installation	Under-Counter
N° baskets	2
EAN code	8017709303716



Programs



Number of programs	5	Delicates	Yes
Washing temperatures	45, 50, 65, 70 °F	Normal	Yes
Mix	Yes	Pots & Pans	Yes
Daily (half load)	Yes		

Options

Professional option	Intensive washing zone option
---------------------	-------------------------------

Baskets



Basket components finish	Gray	Lower basket	Fixed racks
Upper basket	Central fixed racks	Lower basket with anti-drip inserts	Yes
Glass holder	Yes	Largest loadable dish in lower basket	35,0 inches
Upper basket height adjustment	On two height levels	Colour Inner Components	Blue
Largest loadable dish in upper basket	18,0 inches	Cutlery basket	Yes

Technical Features



Width	23 9/16 "	Drying system	Natural condensation drying
Depth	22 7/16 "	Tube material	Stainless steel
Height	32 3/16 "	Filter	Stainless steel
Program symbols	Symbols	Concealed heating element	Yes
On/off indicator	Yes	Hinges	Self-balancing with fixed hinges
Rinse aid indicator	Light	Min. and max plinth height	3.9" - 6.6"
End-of-cycle indicator	Light on display, with acoustic signal	Adjustable feet	2 3/4", from 33 7/8" to 36 5/8"
Auto switch-off	Yes	Additional gaskets	Yes
Washing system	Standard	Back cover	Yes
Third spray arm	Single	Depth of dishwasher with open door (mm)	1146 mm
Flood protection system	Single Aquastop	Top cover	Metal sheet
Max water hardness	100°fH;58°dH		

Electrical Connection

Connected power	1800 W	Connection type	Single-phase
Current	10 A	Power supply cable length	140 "
Voltage	110-120 V	Plug	(A) USA & Mexico
Frequency (Hz)	60 Hz		

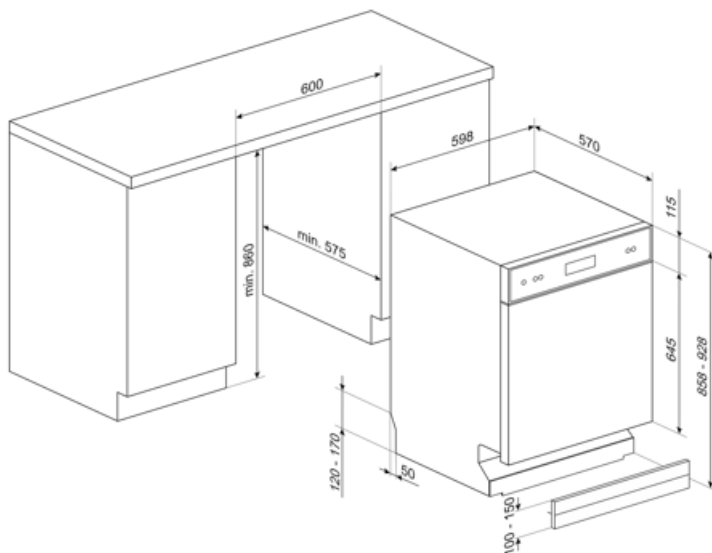

Compatible Accessories

KITPL60FABB



Toe kick Kit in White colour with adjustable height. Can be fitted over all the fully integrated and underbench models with Fixed Fulcrum. Can be installed also on the models with variable fulcrum or flexifit hinges.

KITPL60FABX



Toe kick Kit in Stainless Steel with adjustable height. Can be fitted over all the fully integrated and underbench models with Fixed Fulcrum. Can be installed also on the models with variable fulcrum or flexifit hinges.

KITPL60FABN











Toe kick Kit in Black colour with adjustable height. Can be fitted over all the fully integrated and underbench models with Fixed Fulcrum. Can be installed also on the models with variable fulcrum or flexifit hinges.

KITPLV2



Kit extension for dishwasher and washing machine: lenght mt. 2

Symbols glossary

	Acquastop: Some Smeg dishwashers are equipped with a simple Acquastop: float sensor in the bottom which is necessary to prevent an accidental leakage of water inside the appliance.		Anti-drip: Some models of dishwashers are equipped with special polymer nozzles anti-drip, that improve the process of drying.
	COMM_HEIGHT_86_72dpi		Noise Level: Excellent insulation and special devices keep noise to a minimum.
	1/2 load: This program is designed for washing dishes not heavily soiled with partial load of the dishwasher.		Delicate: Delicate washing program is designed for delicate dishes which are not heavily soiled.
	Normal programme: The normal programme is suitable for normal degrees of dirt for everyday use.		The symbols show the number of plate settings of the dishwasher.