

LSPU8643WH



Product Family	Dishwashers
Commercial width	60 cm
Commercial height	86 cm
Installation	Under counter built-in
N° baskets	3, FlexiDuo
EAN code	8017709303730



Programs



N. of programmes	10+1	Delicate	Yes
Washing temperatures	38, 45, 50, 55, 65, 70, 75 °F	Normal	Yes
Soak	Yes	Crystal & China	Yes
Express 27'	Yes	Eco express	Yes
Mix	Yes	Express 60'	Yes
Self clean	Yes	Pots & Pans	Yes
Sterilise	Yes		

Options

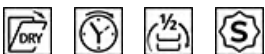

Dry Assist option	Yes	1/2 load FlexiZone option	Yes
Delay timer option	Up to 24 hours	Special programs option	Yes

Baskets



Basket components colour	Grey	Lower Basket	With 2 foldable racks
Upper Basket	With 1 foldable rack	Lower basket with anti-drip inserts	Yes
Glass holder	Yes	Largest loadable dish in lower basket	35,0 inches
Height adjustment of the upper basket	On three levels (5 cm)		

Sliding Guides Extra Glide	Yes	Colour Inner Components	Blue
Largest loadable dish in upper basket	18,0 inches	Cutlery basket	Yes

Technical Features



Width (mm)	23 9/16 "	Flood protection system	Total Acquastop
Depth (mm)	22 7/16 "	Max water hardness	100°fH;58°dH
Display type	LED (external)	Drying system	Natural condenser drying, with Dry Assist automatic door opening system at the end of the cycle
Product Height (mm)	32 3/16 "	Tub material	Stainless steel
Display	Delayed start, Programme time indicator, Time to end indication	Filter	Stainless steel
Programme graphics	Symbols	Concealed heating element	Yes
On/off indicator	Yes	Hinges	Self balancing with variable hinges
Salt light indicator	Light	Min. and max plinth height	98 - 168 mm
Rinse aid indicator	Light	Adjustable feet	7cm, from 860 to 930 mm
Progress indicator	Yes	Additional gaskets	Yes
End of cycle indicator	On display, with acoustic signal	Back cover	Yes
Auto switch-off	Yes	Depth of dishwasher with open door (mm)	1146 mm
Washing system	Orbital	Top cover	Metallic sheet
Third spray arm	Single	Energy Star	Yes
Water softener	With electronic setting		

Electrical Connection

Connected power	1800 W	Type of connection	Single-phase
Current	10 A	Power supply cable length	140 "
Voltage	110-120 V	Plug	(A) USA e Messico
Frequency (Hz)	60 Hz		

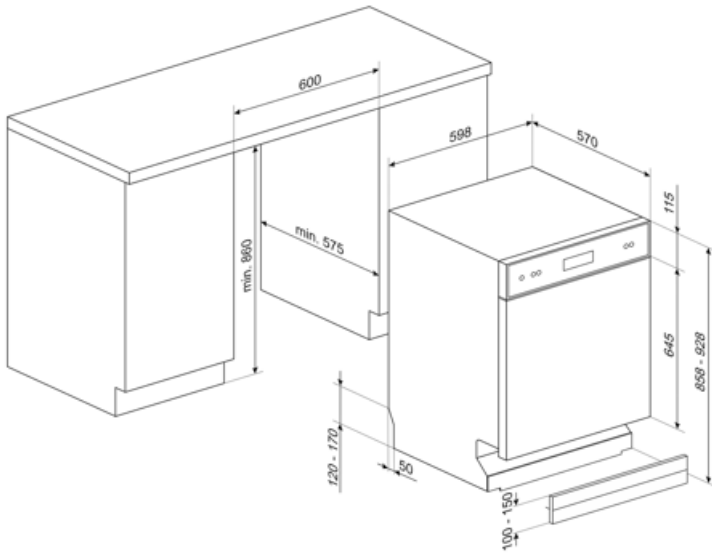

Compatible Accessories



KITGH

Kit glass holder. It has to be fitted on the first basket but only if there are foldable racks



KITPL60N

Toekick Kit in Black colour with adjustable height and deepness. Can be installed over all the fully integrated and underbench models with variable fulcrum or flexifit hinges.



KITPLV2

Kit extension for dishwasher and washing machine: lenght mt. 2



KITPL60B



















Toekick Kit in White colour with adjustable height and deepness. Can be installed over all the fully integrated and underbench models with variable fulcrum or flexifit hinges.



KITPL60X

Toekick Kit in Stainless Steel with adjustable height and deepness. Can be fitted over all the fully integrated and underbench models with variable fulcrum or flexifit hinges.

Symbols glossary

 To improve the drying of dishes without leaving stains.	 86 cm high
 Delay Timer: Option to postpone the start of the desired programme by up to 24 hours in order to programme the dishwasher to run at the desired time.	 LED display: to show programmes, functions and options selected and the time to the end of the cycle.
 The Dry Assist option ensures optimal drying of the dishes by automatically opening the door at the end of the wash cycle. Reducing the rinse temperature.	 FlexiDuo: The FlexiDuo 3rd cutlery basket allows you to arrange cutlery or small cups, ladles, or bulky utensils however you like: it consists of two separate and moveable modules.
 FlexiZone: The 1/2 load flexizone allows you to wash a reduced load saving energy, water and time and there are no restrictions on where the items are placed.	 The ExtraGlide guides system makes the second basket run even smoother and softer. It facilitates movement even when fully loaded, and thanks to the increased excursion, facilitates the insertion of dishes into the basket.
 Noise Level: Excellent insulation and special devices keep noise to a minimum.	 Orbital wash system distributes water evenly throughout the 60cm dishwasher cavity, directing water with precision to ensure an excellent wash.
 Delicate: Delicate washing program is designed for delicate dishes which are not heavily soiled.	 Mix: The Mix programme is suitable for mixed crockery and everyday pots and pans, without any particular incrustation.
 Soak programme: The soak programme provides a rinse to prevent dirt from drying.	 Express 27': The Express 27' programme is a quick wash cycle, at low temperatures, for lightly soiled dishes.
 13 place settings: Number of place settings.	 Total Acquastop: In addition to the partial Acquastop protection present in all Smeg dishwashers, some models have an electronic device fitted to the water intake hose, which monitors water levels in the machine, detects leaks in the hose and switches off the water supply immediately when necessary.
 Dishwasher cleaning cycle. The cycle should be started with the machine empty, without dishes. It is recommended to run the program every 2-3 months, using special dishwasher detergents.	 Allows you to enable additional programs when selected together with any wash cycle.
 STERYL 75°: Intensive wash cycle ideal for plates, pots, pans, cutting boards, feeding bottles.	