

# LSPU8653X



<b>Product family</b>	Dishwashers
<b>Width</b>	24"
<b>Commercial height</b>	86 cm
<b>Installation</b>	Under-Counter
<b>N° baskets</b>	3, FlexiDuo
<b>EAN code</b>	8017709303754



## Programs



<b>Number of programs</b>	10+1	<b>Sterilize</b>	Yes
<b>Washing temperatures</b>	38, 45, 50, 55, 65, 70, 75 °F	<b>Daily (half load)</b>	Yes
<b>Soak</b>	Yes	<b>Delicates</b>	Yes
<b>Express</b>	Yes	<b>Auto</b>	Yes
<b>Mix</b>	Yes	<b>Crystal &amp; China</b>	Yes
<b>Intensive</b>		<b>Eco express</b>	Yes
<b>Self Clean</b>	Yes	<b>Pots &amp; Pans</b>	Yes

## Options



<b>Dry Assist option</b>	Yes	<b>FlexiZone half-load option</b>	Yes
<b>Delay start</b>	Up to 24 hours	<b>Special programs option</b>	Yes

## Baskets



<b>Basket components finish</b>	Gray	<b>Lower basket</b>	With 4 foldable racks
<b>Upper basket</b>	3 foldable racks	<b>Lower basket with anti-drip inserts</b>	Yes
<b>Upper basket height adjustment</b>	On 3 levels	<b>Largest loadable dish in lower basket</b>	35,0 inches

Sliding Guides Extra Glide	Yes	Colour Inner Components	Blue
Largest loadable dish in upper basket	18,0 inches	Cutlery basket	Yes

## Technical Features

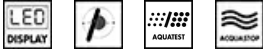

Width	23 9/16 "	Flood protection system	Total Aquastop
Depth	22 7/16 "	Max water hardness	100°fH;58°dH
Display type	OLED	Drying system	Dry Assist
Height	32 3/16 "	Internal lighting	White LED
Display	Delay start, Program progress indicator, Time-to-end indicator	Filter	Stainless steel
Program symbols	Symbols	Concealed heating element	Yes
On/off indicator	Yes	Hinges	Self-balancing with variable hinges
Salt indicator	Light	Min. and max plinth height	3.9" - 6.6"
Rinse aid indicator	Light	Adjustable feet	2 3/4", from 33 7/8" to 36 5/8"
Program progress indicator	Yes	Additional gaskets	Yes
End-of-cycle indicator	On display, with acoustic signal	Back cover	Yes
Auto switch-off	Yes	Depth of dishwasher with open door (mm)	1146 mm
Washing system	Planetarium	Top cover	Metal sheet
Third spray arm	Single	Energy Star	Yes
Water softener	With electronic setting		
Turbidity sensor Aquatest	Yes		

## Electrical Connection

Connected power	1800 W	Connection type	Single-phase
Current	10 A	Power Cord Length	140 "
Voltage	110-120 V	Plug	(A) USA & Mexico
Frequency	60 Hz		

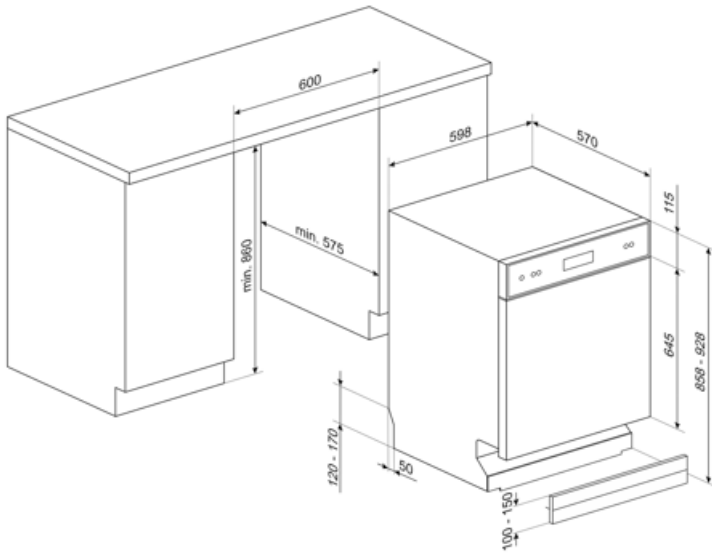

## Compatible Accessories



### KITGH

Kit glass holder. It has to be fitted on the first basket but only if there are foldable racks



### KITPL60B

Toe kick Kit in White colour with adjustable height and deepness. Can be installed over all the fully integrated and underbench models with variable fulcrum or flexifit hinges.



### KITPL60N

Toe kick Kit in Black colour with adjustable height and deepness. Can be installed over all the fully integrated and underbench models with variable fulcrum or flexifit hinges.

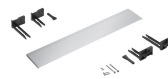

### KITPL60X























Toe kick Kit in Stainless Steel with adjustable height and deepness. Can be fitted over all the fully integrated and underbench models with variable fulcrum or flexifit hinges.



### KITPLV2

Kit extension for dishwasher and washing machine: lenght mt. 2

## Symbols glossary

	Aquatest measures the clarity of the water during an auto program, and automatically ensures the minimum consumption of water and energy.		Anti-drip: Some models of dishwashers are equipped with special polymer nozzles anti-drip, that improve the process of drying.
	COMM_HEIGHT_86_72dpi		Delay Timer: The delay timer can postpone the start of the program by up to 24 hours.
	LED display: to show programmes, functions and options selected and the time to the end of the cycle.		Enersave: At the end of the drying cycle a special device slowly automatically opens the door a few centimeters, to ensure perfect drying and to save up to 20% of energy on some models.
	FlexiDuo: The FlexiDuo 3rd cutlery basket allows you to arrange cutlery or small cups, ladles, or bulky utensils however you like: it consists of two separate and moveable modules.		FlexiZone: The ½ load flexizone allows you to wash a reduced load saving energy, water and time and there are no restrictions on where the items are placed.
	The new ExtraGlide guide system, available on top of the range models, makes the second basket even smoother and softer. In fact, it facilitates the extraction of the introduction, even at full load and, for the greater excursion, the insertion of crockery is also facilitated in the rear part.		Noise Level: Excellent insulation and special devices keep noise to a minimum.
	PLANETARIUM_WASHING_SYSTEM_72dpi		Delicate: Delicate washing program is designed for delicate dishes which are not heavily soiled.
	1/2 load: This program is designed for washing dishes not heavily soiled with partial load of the dishwasher.		Delicate: Delicate washing program is designed for delicate dishes which are not heavily soiled.
	Normal programme: The normal programme is suitable for normal degrees of dirt for everyday use.		Soak programme: The soak programme provides a rinse to prevent dirt from drying.
	Rapid 27 Mins: The rapid 27 mins quick program takes just 27 minutes to wash a load.		The symbols show the number of plate settings of the dishwasher.
	Total Acquastop: In addition to the partial Acquastop protection present in all Smeg dishwashers, some models have an electronic device fitted to the water intake hose, which monitors water levels in the machine, detects leaks in the hose and switches off the water supply immediately when necessary.		Dishwasher cleaning cycle. The cycle should be started with the machine empty, without dishes. It is recommended to run the program every 2-3 months, using special dishwasher detergents.
	Allows you to enable additional programs when selected together with any wash cycle.		STERYL 75°: Intensive wash cycle ideal for plates, pots, pans, cutting boards, feeding bottles.