

## LVFABBL3



Product familie	Vaatwasser
Commerciële breedte	60 cm
Nishoogte	85 cm
Installatie	Vrijstaand
Aantal manden	3 met FlexiDuo besteklade
Motor	Inverter 2.0
EAN-code	8017709305116



## Programma's



Aantal programma's	10+1	Auto sensor 45-65	Ja
Wastemperatuur	38, 45, 50, 55, 65, 70, 75 °C	Mix	Ja
Weken	Ja	Stil (-2dB)	Ja
Snel 27'	Ja	Intensief	Ja
Glazen	Ja	Automatische reiniging	Ja
Snel - Volledig 60'	Ja	Steriliseren	
ECO	Ja	Hygiëne 99,9%	Ja

## Opties



Dry Assist+	Ja	FlexiZone ½ (halve beladingsmogelijkheid)	Ja
Start uitstel optie	Tot 24 uur, i.c.m. automatisch spoelen	Optie speciale programma's	Ja

## Korven



Kleur korven	Grijs	Grootste bord in bovenste mand	19,0 cm
Kleur korfcomponenten	Grijs	Onderste mand	Met 4 neerklapbare rekken
Handgreep	In plastic with stainless steel insert on upper and lower basket	Onderste mand met anti-druppel systeem	Ja
Bovenste mand	Met 3 neerklapbare rekken		

<b>Glass holder</b>	Ja	<b>Grootste bord in onderste mand</b>	30,0 cm
<b>Aanpasbare hoogte bij bovenste mand</b>	3 niveaus	<b>Kleur interne onderdelen</b>	Grijs
<b>Bovenste mand met EasyGlide systeem</b>	Ja	<b>Bestekmandje</b>	No

## Technische specificaties



<b>Breedte product (mm)</b>	598 mm	<b>Aquatest</b>	Ja
<b>Diepte product (mm)</b>	627 mm	<b>Aquastop</b>	Total Aquastop
<b>Type display</b>	1 cijfer	<b>Water toevoer</b>	Enkel; koud en warm water tot 60°C - energiebesparing tot 35%
<b>Hoogte product (mm)</b>	885 mm	<b>Maximale waterhardheid</b>	100°FH;58°dH
<b>Bediening</b>	Elektronisch	<b>Droogstelsysteem</b>	Natuurlijk condensatiedrogen, met DryAssist + automatische deuropening einde cyclus
<b>Display</b>	Instelling start uitstel	<b>Materiaal kuip</b>	Inox
<b>Grafische weergave programma's</b>	Symbolen	<b>Filter</b>	Inox
<b>Indicator aan/uit</b>	Ja	<b>Warmte element</b>	Ja
<b>Indicator zout</b>	Indicator (lampje)	<b>Scharnieren</b>	Zelfbalancerend met vast steunpunt
<b>Indicator glansspoelmiddel</b>	Indicator (lampje)	<b>Aanpasbare voetjes</b>	Alleen voor niveau aanpassing
<b>Indicator einde cyclus</b>	Geluidssignaal	<b>Bedekking achter</b>	Ja
<b>Wassysteem</b>	Planetarium wassysteem	<b>Diepte vaatwasser met open deur (mm)</b>	1171 mm
<b>Derde sproeiarm</b>	Enkel	<b>Bovenbedekking</b>	Van kunststof
<b>Water verzachter</b>	Elektronisch instelbaar		

## Prestaties/Energie label - Reg. 2019

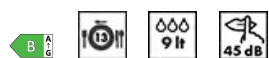

<b>Energie-efficiëntieklasse</b>	B	<b>Duur langste programma</b>	4:25 h:min
<b>Energy consumption [per 100 cycles, based on the eco programme]</b>	63 kWh	<b>Geluidsniveau</b>	45 dB(A) re 1 pW
<b>Rated capacity (ps)</b>	13	<b>Emissieklasse voor akoestisch luchtgeluid</b>	C
<b>Water verbruik (per cyclus)</b>	9,0 litres	<b>Energy efficiency Index (EEI)</b>	37,9

## Elektrische aansluiting

<b>Aansluitwaarde</b>	1800 W	<b>Type of connection</b>	Eenfasig
<b>Stroom</b>	10 A	<b>Lengte voedingskabel</b>	140 cm
<b>Spanning</b>	220-240 V	<b>Stekker</b>	(F;E) Schuko
<b>Frequentie</b>	50 Hz		

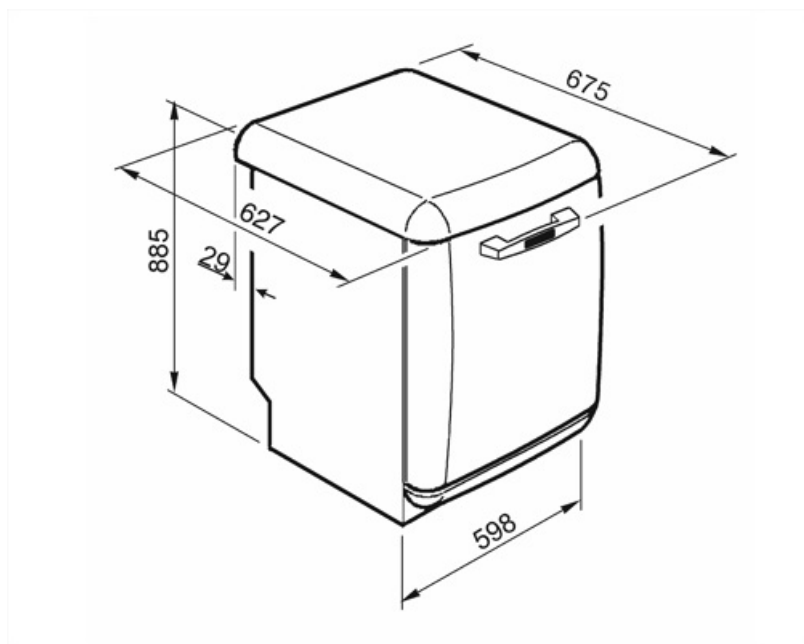

---

## Compatible Accessories

---

### KITGH



Kit glass holder. It has to be fitted on the first basket but only if there are foldable racks

### KITPLV2



Kit extension for dishwasher and washing machine: lenght mt. 2

### KITINC

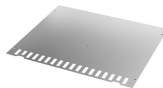

---

## Alternative products





















---



**LVFABCR3**

**Kleur: Crème**

## Symbols glossary

	<p>The Aquatest sensor is an electronic sensor that measures the degree of water transparency at the end of the initial soaking phase. Based on the values measured, the sensor sets the most suitable programme, thus obtaining the best washing results with the minimum amount of water.</p>		<p>To improve the drying of dishes without leaving stains.</p>
	<p>Delay Timer: Option to postpone the start of the desired programme by up to 24 hours in order to programme the dishwasher to run at the desired time.</p>		<p>EasyGlide: Convenient EasyGlide system for easy unloading of the appliance that allows reaching maximum flexibility of load of the machine.</p>
	<p>FlexiDuo: The FlexiDuo 3rd cutlery basket allows you to arrange cutlery or small cups, ladles, or bulky utensils however you like: it consists of two separate and moveable modules.</p>		<p>FlexiZone: The ½ load flexizone allows you to wash a reduced load saving energy, water and time and there are no restrictions on where the items are placed.</p>
	<p>Noise Level: Excellent insulation and special devices keep noise to a minimum.</p>		<p>The Planetarium washing system, with high rotations per minute, guarantees complete coverage of the tank, thanks to the simultaneous rotation of base and sprayers, and excellent washing results.</p>
	<p>Het automatische programma regelt de lengte van een cyclus afhankelijk van de behoefte aan voorwas en het aantal benodigde spoelbeurten.</p>		<p>Crystals: The Crystals programme is dedicated to delicate dishes such as glasses and china.</p>
	<p>Het ECO programma is een economische wascyclus die een kleine hoeveelheid water en energie gebruikt voor de meest milieuvriendelijke reinigingsoptie.</p>		<p>Het normaal programma is geschikt voor gemengde dagelijkse vaat en potten en pannen, zonder specifieke aangekoekte etensresten.</p>
	<p>Het weekprogramma zorgt voor een spoeling om te voorkomen dat vuil opdroogt.</p>		<p>Snel programma 27 minuten</p>
	<p>De UltraClean optie voert een laatste spoeling uit op een hoge temperatuur van 70°C die 99,9% van alle bacteriën wegneemt.</p>		<p>13 place settings: Number of place settings.</p>
	<p>Total Acquastop: In addition to the partial Acquastop protection present in all Smeg dishwashers, some models have an electronic device fitted to the water intake hose, which monitors water levels in the machine, detects leaks in the hose and switches off the water supply immediately when necessary.</p>		<p>System WaterSave ensures the best washing results with minimal water consumption depending on the model of dishwasher.</p>
	<p>Voor normaal vervuilde gemengde ladingen zoals borden en pannen, zelfs met opgedroogde resten. De gerechten worden in 60 minuten gewassen en gedroogd.</p>		<p>De vaatwasser voert een automatische zelfreinigingscyclus uit</p>



Een wascyclus die gebruikt kan worden voor vervuilde vaat, zelf met opgedroogde resten. Deze cyclus heeft een minimaal geluidsniveau en is daarom ideaal om 's nachts te laten draaien.



The Dry Assist + option, in addition to saving energy, ensures perfect drying of the dishes by opening the door automatically at the end of the washing cycle.



HYGINE 99,9% Wasprogramma op hoge temperatuur. De 75° spoeling garandeert de verwijdering van 99,9% van de ziektekiemen en bacteriën.



Deze functie laat je toe de extra programma's te selecteren wanneer deze worden gecombineerd met eender welke wascyclus. Na de nodige wascyclus geselecteerd te hebben, duw op deze knop.



Energie-efficiëntieklasse



Het werk gericht op continue verbetering heeft de creatie mogelijk gemaakt van de tweede generatie van de Inverter-motor 2.0, die wordt gekenmerkt door een grotere efficiëntie en duurzaamheid in de loop van de tijd, wat zeer hoge prestaties en een lager energieverbruik en een lager geluidsniveau mogelijk maakt.

