

LVFABCR3



| | |
|-------------------|---------------|
| Product Family | Dishwashers |
| Commercial width | 60 cm |
| Commercial height | 85 cm |
| Installation | Free-standing |
| N° baskets | 3, FlexiDuo |
| Motor | Inverter 2.0 |
| EAN code | 8017709305109 |



Programs



| | | | |
|---------------------------|-------------------------------|-------------------|-----|
| N. of programmes | 10+1 | Auto sensor 45-65 | Yes |
| Washing temperatures | 38, 45, 50, 55, 65, 70, 75 °C | Mix | Yes |
| Soak | Yes | Quiet (-2 dB) | Yes |
| Express 27' | Yes | Intense | Yes |
| Crystal | Yes | Self clean | Yes |
| Full express - 60 minutes | Yes | Sterilise | Yes |
| ECO | Yes | Hygiene 99,9% | Yes |

Options



| | | | |
|---------------------------|---------------|----------------------------|-----|
| Dry Assist+ option | Yes | Intensive wash zone option | Yes |
| Delay timer option | Up to 9 hours | Special programs option | Yes |
| 1/2 load FlexiZone option | Yes | | |

Baskets



| | | | |
|--------------------------|------|---------------------------------------|---------|
| Basket colour | Grey | Upper basket with EasyGlide System | Yes |
| Basket components colour | Grey | Largest loadable dish in upper basket | 19,0 cm |

| | | | |
|--|--|--|--|
| Handle | In plastic with stainless steel insert on upper and lower basket | Lower Basket | With 4 foldable racks |
| Upper Basket | With 3 foldable racks | Lower basket with anti-drip inserts | Yes |
| Glass holder | Yes | Largest loadable dish in lower basket | 30,0 cm |
| Height adjustment of the upper basket | On three levels (5 cm) | Colour Inner Components | Grey Flexiduo, Grey Planetarium, Cup shelves, Handle, Anti drop inserts, Cutlery basket: same colour of Dishwasher |

Technical Features



| | | | |
|-------------------------------|-------------------------|--|---|
| Width (mm) | 598 mm | Turbidity sensor | Yes |
| Depth (mm) | 627 mm | Aquatest | |
| Display type | LED display (1 digit) | Flood protection system | Total Acquastop |
| Product Height (mm) | 885 mm | Water supply | Single; cold/hot water max. 60°C - energysave with hot water up to 35% |
| Controls | Electronic | Max water hardness | 100°FH;58°dH |
| Display | Delayed start | Drying system | Natural condenser drying, with Dry Assist + automatic door opening system at the end of the cycle |
| Programme graphics | Symbols | Tube material | Stainless steel |
| On/off indicator | Yes | Filter | Stainless steel |
| Salt light indicator | Light | Concealed heating element | Yes |
| Rinse aid indicator | Light | Hinges | Self balancing with fixed hinges |
| End of cycle indicator | Acoustic signal | Adjustable feet | Just for levelling |
| Washing system | Planetarium | Back cover | Yes |
| Third spray arm | Single | Depth of dishwasher with open door (mm) | 1171 |
| Water softener | With electronic setting | Top cover | In plastic |

Performance / Energy Label - Reg. 2019

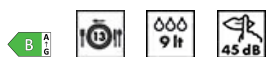

| | | | |
|--|------------|---|------------------|
| Energy Efficiency Class | B | Programme duration | 4:25 h:min |
| Energy consumption [per 100 cycles, based on the eco programme] | 63 KWh | Airborne acoustical noise emissions | 45 dB(A) re 1 pW |
| Rated capacity (ps) | 13 | Airborne acoustical noise emission class | C |
| Water consumption [per cycle] | 9.0 litres | Energy efficiency Index (EEI) | 37.9 |

Electrical Connection

| | | | |
|------------------------|--------------|----------------------------------|--------------|
| Plug | (F;E) Schuko | Frequency (Hz) | 50 Hz |
| Connected power | 1800 W | Type of connection | Single-phase |
| Current | 10 A | Power supply cable length | 140 cm |
| Voltage | 220-240 V | | |

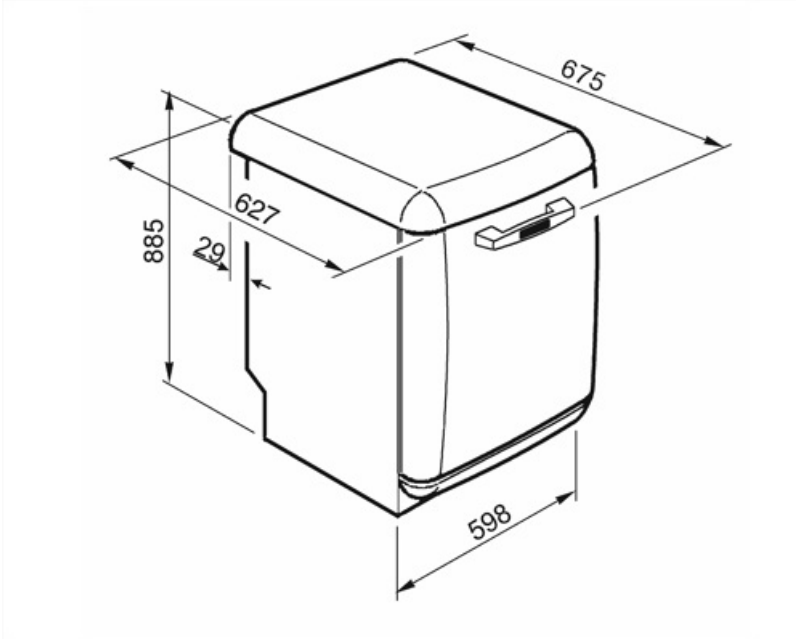

Compatible Accessories

KITGH

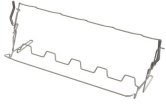

Kit glass holder. It has to be fitted on the first basket but only if there are foldable racks

KITPLV2



Kit extension for dishwasher and washing machine: lenght mt. 2

KITINC

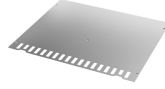





















Alternative products



LVFABBL3

Colour: Black

Symbols glossary

| | | | |
|--|---|---|---|
|  | <p>The Aquatest sensor is an electronic sensor that measures the degree of water transparency at the end of the initial soaking phase. Based on the values measured, the sensor sets the most suitable programme, thus obtaining the best washing results with the minimum amount of water.</p> |  | <p>To improve the drying of dishes without leaving stains.</p> |
|  | <p>Delay Timer: Option to postpone the start of the desired programme by up to 24 hours in order to programme the dishwasher to run at the desired time.</p> |  | <p>EasyGlide: Convenient EasyGlide system for easy unloading of the appliance that allows reaching maximum flexibility of load of the machine.</p> |
|  | <p>FlexiDuo: The FlexiDuo 3rd cutlery basket allows you to arrange cutlery or small cups, ladles, or bulky utensils however you like: it consists of two separate and moveable modules.</p> |  | <p>FlexiZone: The ½ load flexizone allows you to wash a reduced load saving energy, water and time and there are no restrictions on where the items are placed.</p> |
|  | <p>Noise Level: Excellent insulation and special devices keep noise to a minimum.</p> |  | <p>The Planetarium washing system, with high rotations per minute, guarantees complete coverage of the tank, thanks to the simultaneous rotation of base and sprayers, and excellent washing results.</p> |
|  | <p>Auto 45°- 65°: The auto programme regulates the length of a cycle depending on the need for a pre-wash and the number of rinses required.</p> |  | <p>Crystals: The Crystals programme is dedicated to delicate dishes such as glasses and china.</p> |
|  | <p>Eco: Eco, this economic wash programme uses a low amount of water and energy in order to provide the most environmentally friendly cleaning option.</p> |  | <p>Mix: The Mix programme is suitable for mixed crockery and everyday pots and pans, without any particular incrustation.</p> |
|  | <p>Soak programme: The soak programme provides a rinse to prevent dirt from drying.</p> |  | <p>Express 27': The Express 27' programme is a quick wash cycle, at low temperatures, for lightly soiled dishes.</p> |
|  | <p>Ultraclean: The Ultraclean option performs a final rinse at a high temperature of 70°C eliminating virtually all bacteria.</p> |  | <p>13 place settings: Number of place settings.</p> |
|  | <p>Total Acquastop: In addition to the partial Acquastop protection present in all Smeg dishwashers, some models have an electronic device fitted to the water intake hose, which monitors water levels in the machine, detects leaks in the hose and switches off the water supply immediately when necessary.</p> |  | <p>System WaterSave ensures the best washing results with minimal water consumption depending on the model of dishwasher.</p> |
|  | <p>Quick wash cycle for normally soiled mixed loads such as dishes and pans, even with dried-on residues. Dishes are washed and dried in 60 minutes.</p> |  | <p>Dishwasher cleaning cycle. The cycle should be started with the machine empty, without dishes. It is recommended to run the program every 2-3 months, using special dishwasher detergents.</p> |



SILENT: Wash cycle suitable for normally soiled dishes, even with dried-on residues. Ensures maximum noise reduction and is therefore ideal if you wish to run it during the night.



The Dry Assist + option, in addition to saving energy, ensures perfect drying of the dishes by opening the door automatically at the end of the washing cycle.



HYGIENE 99.9% High-temperature washing programme. The 75° rinse guarantees the removal of 99.9% of germs and bacteria.



Allows you to enable additional programs when selected together with any wash cycle. After having selected the required wash cycle, press the button (



Energy efficiency class B



The work aimed at continuous improvement has allowed the creation of the second generation of the Inverter motor 2.0, characterised by greater efficiency and durability over time, which allows very high performance and a lower energy consumption and noise level.



Benefit (TT)

FlexiDuo

The flexible third basket provides additional space, adapting to the load to accommodate various types of dishes, ensuring optimal organization and efficient use of interior capacity

The third FlexiDuo basket consists of two separate sections that can be handled independently of each other, stacked and/or removed, offering loading flexibility for every need. Depending on the arrangement, it allows cups, tall glasses, bulky utensils and pots and pans to be placed in the upper basket.

Planetarium Wash System

Full and deep wash coverage thanks to the advanced movement of the spray arm, an innovation patented by Smeg

Smeg's patented Planetarium Wash System guarantees impeccable cleaning. With a simultaneous double movement of the sprayer and 65 rotations per minute, it reaches every nook and cranny for extraordinary results. Dishes, glasses and utensils will be perfectly clean in no time. An intelligent system where efficiency and style meet, delivering brilliant results effortlessly.

DryAssist+

The Dry Assist+ system of automatic door opening at the end of the cycle ensures fast and energy-efficient drying