

LVFABCR3



Familie	Vaatwasser
Commerciële breedte	60 cm
Nishoogte	85 cm
Installatie	Vrijstaand
Aantal korven	3, FlexiDuo
Motor	Inverter 2.0
EAN-code	8017709305109



Programs



Aantal programma's	10+1	Auto sensor 45-65	Ja
Wastemperatuur	38, 45, 50, 55, 65, 70, 75 °C	Mix	Ja
Weken	Ja	Stil (-2dB)	Ja
Snel 27'	Ja	Intensief	Ja
Krystal	Ja	Zelf reinigen	Ja
Snel - Volledig 60'	Ja	Hygiëne 99,9%	Ja
Eco	Ja		

Opties



Dry Assist + opties	Ja	FlexiZone ½ (halve beladingsmogelijkheid)	Ja
Delay timer optie	Tot 24 uur, i.c.m. automatisch spoelen	Optie speciale programma's	Ja

Korven



Kleur korven	Grijs	Bovenmand met EasyGlide System:	Ja
Kleur korfcomponenten	Grijs		
Handgreep	Van kunststof met roestvrijstalen inzet op boven- en onderrek		
Bovenkorf	Met 3 opvouwbaar rekken		

Glazen houder	Ja	Maximum afmetingen bord dat in bovenste korf kan worden geladen	19,0 cm
In hoogte verstelbare bovenkorf	3 niveaus	Onderkorf	Met 4 opvouwbare rekken
		Onderkorf met anti-drup inserts	Ja
		Maximum afmetingen bord dat in onderste korf kan worden geladen	30,0 cm
		Kleur binnenonderdelen	Grijs FlexiDuo, Grijs Planetarium, Cup shelves, Handle, Anti drop inserts, Cutlery basket: same colour of Dishwasher

Technische specificaties



Breedte product	598 mm	Aquatest sensor	Ja
Diepte product	627 mm	Overstroombeveiliging	Total Acquastop
Type display	1 cijfer	Watertoevoer	Enkel; koud en warm water tot 60°C - energiebesparing tot 35%
Hoogte product	885 mm	Maximale waterhardheid	100°FH;58°dH
Bediening	Elektronisch	Droogstelsysteem	Natuurlijk condensor drogen met Dry Assist + automatische deuropeningssysteem aan het einde van de cyclus
Display	Instelling Delay timer	Materiaal kuip	Roestvrij staal
Grafische weergave programma's	Symbolen	Filter	Roestvrij staal
Aan/uit indicator	Ja	Verborgene verwarmingselement	Ja
Zout indicator	Indicator (lampje)	Scharnieren	Zelfbalancerend met vast steunpunt
Glansspoelmiddel indicator	Indicator (lampje)	Verstelbare voetjes	Alleen voor niveau aanpassing
Indicator einde cyclus	Akoestisch signaal	Back cover	Ja
Wassysteem	Planetarium	Diepte vaatwasser met open deur (mm)	1171
Derde sproeiarm	Enkel	Bovenbedekking	Van kunststof
Waterontkalker	Elektronisch instelbaar		

Performance / Energy Label - Reg. 2019

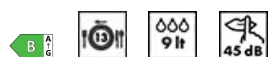

Energie-efficiëntieklasse B (wascyclus)	Programmaduur	4:25 h:min
	Geluidsniveau Akoestisch geluidsemisatieklasse	45 dB(A) re 1 pW C

Energy consumption 63 kWh
[per 100 cycles, based
on the eco programme]

Energy efficiency Index 37,9
(EEI)

Nominale capaciteit (ps) 13

Water verbruik (per
cyclus) 9,0 litres

Elektrische aansluiting

Stekker (F;E) Schuko
Aansluitwaarde 1800 W
Stroom 10 A
Spanning 220-240 V

Frequentie 50 Hz
Type aansluiting Single-phase
Lengte voedingskabel 140 cm

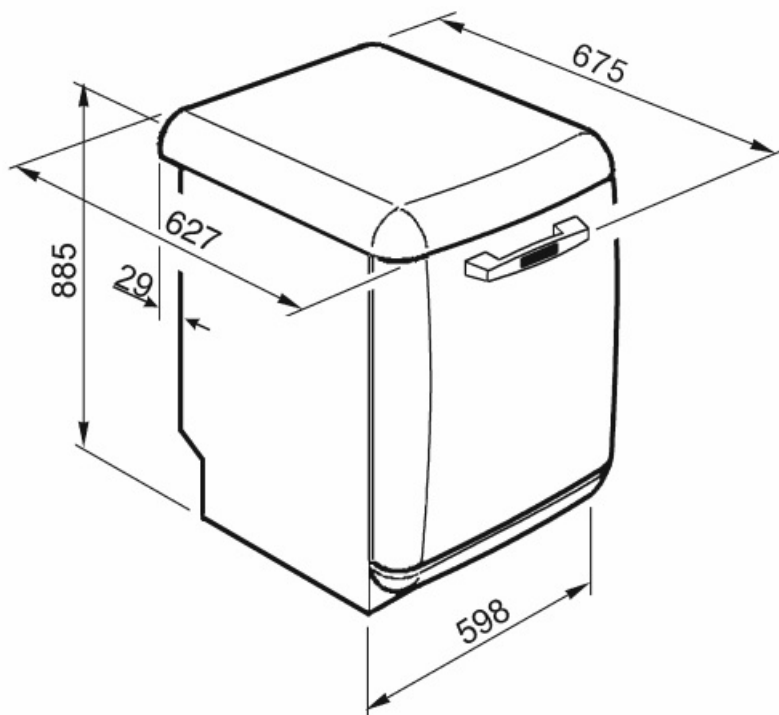

Accessoires niet inbegrepen



KITPLV2

Kit verlengstuk voor vaatwasser en
wasmachine: lengte 2 mtr.

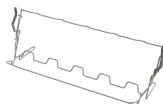

KITGH

Kit glazen houder. Deze moet op de
eerste mand worden gemonteerd,
maar alleen als er inklapbare rekken
zijn























Alternative products



LVFABBL3

Kleur: Zwart

Symbols glossary (TT)

	Aquatest meet de helderheid van het water tijdens een automatisch programma en zorgt automatisch voor een minimaal verbruik van water en energie		To improve the drying of dishes without leaving stains.
	Vertragingstimer: De uitgestelde timer kan de start van het programma tot 24 uur uitstellen.		EasyGlide: handig EasyGlide-systeem voor eenvoudig uitladen van het apparaat en dat maximale flexibiliteit van het laden van de machine mogelijk maakt
	The Dry Assist + option, in addition to saving energy, ensures perfect drying of the dishes by opening the door automatically at the end of the washing cycle.		FlexiDuo: The FlexiDuo 3rd cutlery basket allows you to arrange cutlery or small cups, ladles, or bulky utensils however you like: it consists of two separate and moveable modules.
	FlexiZone: The ½ load flexizone allows you to wash a reduced load saving energy, water and time and there are no restrictions on where the items are placed.		Noise Level: Excellent insulation and special devices keep noise to a minimum.
	The Planetarium washing system, with high rotations per minute, guarantees complete coverage of the tank, thanks to the simultaneous rotation of base and sprayers, and excellent washing results.		Auto 45° - 65°: The auto programme regulates the length of a cycle depending on the need for a pre-wash and the number of rinses required.
	Crystals: The Crystals programme is dedicated to delicate dishes such as glasses and china.		Eco: Eco, this economic wash programme uses a low amount of water and energy in order to provide the most environmentally friendly cleaning option.
	Mix: The Mix programme is suitable for mixed crockery and everyday pots and pans, without any particular incrustation.		Soak programme: The soak programme provides a rinse to prevent dirt from drying.
	Express 27': The Express 27' programme is a quick wash cycle, at low temperatures, for lightly soiled dishes.		Ultraclean: The Ultraclean option performs a final rinse at a high temperature of 70°C eliminating virtually all bacteria.
	13 place settings: Number of place settings.		Total Acquastop: In addition to the partial Acquastop protection present in all Smeg dishwashers, some models have an electronic device fitted to the water intake hose, which monitors water levels in the machine, detects leaks in the hose and switches off the water supply immediately when necessary.
	System WaterSave ensures the best washing results with minimal water consumption depending on the model of dishwasher.		Quick wash cycle for normally soiled mixed loads such as dishes and pans, even with dried-on residues. Dishes are washed and dried in 60 minutes.
	Dishwasher cleaning cycle. The cycle should be started with the machine empty, without dishes. It is recommended to run the program every 2-3 months, using special dishwasher detergents.		SILENT: Wash cycle suitable for normally soiled dishes, even with dried-on residues. Ensures maximum noise reduction and is therefore ideal if you wish to run it during the night.



Allows you to enable additional programs when selected together with any wash cycle. After having selected the required wash cycle, press the button (



HYGIENE 99.9% High-temperature washing programme. The 75° rinse guarantees the removal of 99.9% of germs and bacteria.



Energy efficiency class B



The work aimed at continuous improvement has allowed the creation of the second generation of the Inverter motor 2.0, characterised by greater efficiency and durability over time, which allows very high performance and a lower energy consumption and noise level.