

LVFABS

Familie	Vaatwasser
Commerciële breedte	60 cm
Nishoogte	85 cm
Installatie	Vrijstaand
Aantal korven	2
EAN-code	8017709232085



Programs



Aantal programma's	5 standaard + 4 Quick Time programma's	Auto sensor 45-65	Ja
Wastemperatuur	38, 45, 50, 65, 70 °C	Ultraclean	Ja
Weken	Ja	ECO Quick	Ja
Snel 27'	Ja	Delicate vaat, snel	Ja
Glas	Ja	Normaal snel	Ja
Eco	Ja	Sterk en snel	Ja

Opties

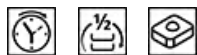

EnerSave optie	Ja	FlexiTabs optie	Ja
Delay timer optie	Tot 24 uur, i.c.m. automatisch spoelen	Quick Time option	Ja
FlexiZone ½ (halve beladingsmogelijkheid)	Ja		

Korven



Kleur korven	Roestvrij staal	Maximum afmetingen bord dat in bovenste korf kan worden geladen	23,5 cm
Kleur korfcomponenten	Getint in externe kleur	Onderkorf	Met 4 opvouwbare rekken

Handgreep	Van kunststof met roestvrijstalen inzet op boven- en onderrek	Onderkorf met anti-drup inserts	Ja
Bovenkorf	Met vaste rekken	Maximum afmetingen bord dat in onderste korf kan worden geladen	30,0 cm
In hoogte verstelbare bovenkorf	3 niveaus	Bestekmandje	13 couverts, schuivend
Bovenmand met EasyGlide System:	Ja		

Technische specificaties



Breedte product	598 mm	Aquatest sensor	Ja
Diepte product	627 mm	Overstroombeveiliging	Total Acquastop
Type display	1 cijfer	Watertoevoer	Enkel; koud en warm water tot 60°C - energiebesparing tot 35%
Hoogte product	885 mm	Maximale waterhardheid	100°FH;58°dH
Bediening	Elektronisch	Droogstelsysteem	Natural condenser drying, with EnerSave automatic door opening system at the end of the cycle
Display	Instelling Delay timer	Materiaal kuip	Roestvrij staal
Grafische weergave programma's	Symbolen	Filter	Roestvrij staal
Aan/uit indicator	Ja	Verborgen verwarmingselement	Ja
Zout indicator	Indicator (lampje)	Scharnieren	Zelfbalancerend met vast steunpunt
Glansspoelmiddel indicator	Indicator (lampje)	Verstelbare voetjes	Alleen voor niveau aanpassing
Indicator einde cyclus	Akoestisch signaal	Back cover	Ja
Wassysteem	Planetarium	Diepte vaatwasser met open deur (mm)	1171
Derde sproeiarm	Enkel	Bovenbedekking	Van kunststof
Waterontkalker	Elektronisch instelbaar		

Elektrische aansluiting

Stekker	(F;E) Schuko	Frequentie	50 Hz
Aansluitwaarde	1800 W	Type aansluiting	Single-phase
Stroom	10 A	Lengte voedingskabel	140 cm
Spanning	220-240 V		

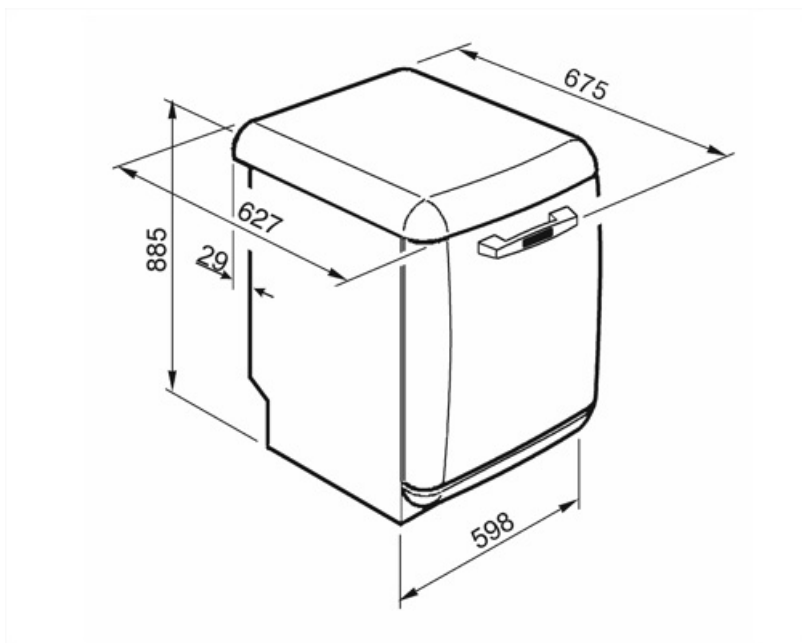

Accessoires niet inbegrepen

KITGH

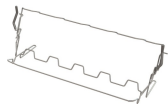

Kit glazen houder. Deze moet op de eerste mand worden gemonteerd, maar alleen als er inklapbare rekken zijn

KITPLV2







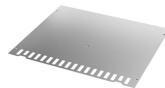













Kit verlengstuk voor vaatwasser en wasmachine: lengte 2 mtr.

KITINC



Symbols glossary (TT)

 <p>Aquatest meet de helderheid van het water tijdens een automatisch programma en zorgt automatisch voor een minimaal verbruik van water en energie</p>	 <p>To improve the drying of dishes without leaving stains.</p>
 <p>A+++: Appliances with this symbol can reduce energy consumption by a further 30% from the standard A energy rating.</p>	 <p>Vertragingstimer: De uitgestelde timer kan de start van het programma tot 24 uur uitstellen.</p>
 <p>EasyGlide: handig EasyGlide-systeem voor eenvoudig uitladen van het apparaat en dat maximale flexibiliteit van het laden van de machine mogelijk maakt</p>	 <p>Ideal for multi-function detergents, this option allows washing to be optimised, with full benefits from the combined-action tablets. When this option is activated, any salt and rinse aid is used.</p>
 <p>FlexiZone: The ½ load flexizone allows you to wash a reduced load saving energy, water and time and there are no restrictions on where the items are placed.</p>	 <p>Noise Level: Excellent insulation and special devices keep noise to a minimum.</p>
 <p>The Planetarium washing system, with high rotations per minute, guarantees complete coverage of the tank, thanks to the simultaneous rotation of base and sprayers, and excellent washing results.</p>	 <p>Auto 45°- 65°: The auto programme regulates the length of a cycle depending on the need for a pre-wash and the number of rinses required.</p>
 <p>Delicate Quick: Program Delicate Quick is suitable for quick washing of delicate dishes.</p>	 <p>Eco: Eco, this economic wash programme uses a low amount of water and energy in order to provide the most environmentally friendly cleaning option.</p>
 <p>Eco: Eco, this economic wash programme uses a low amount of water and energy in order to provide the most environmentally friendly cleaning option.</p>	 <p>Normal Quick: Program Normal Quick is suitable for quick washing of mixed dishes, for everyday use.</p>
 <p>Soak programme: The soak programme provides a rinse to prevent dirt from drying.</p>	 <p>Strong&Fast: This special programme takes less than 1 hour to eliminate the most stubborn dirt and dried on residues.</p>
 <p>13 place settings: Number of place settings.</p>	 <p>Total Acquastop: In addition to the partial Acquastop protection present in all Smeg dishwashers, some models have an electronic device fitted to the water intake hose, which monitors water levels in the machine, detects leaks in the hose and switches off the water supply immediately when necessary.</p>
 <p>System WaterSave ensures the best washing results with minimal water consumption depending on the model of dishwasher.</p>	