

LVS252CSX

Product Family	Dishwashers
Commercial width	60 cm
Commercial height	85 cm
Installation	Free-standing
N° baskets	2
EAN code	8017709305123



Programs



N. of programmes	5	ECO	Yes
Washing temperatures	45, 50, 65, 75 °C	Mix	Yes
Crystal	Yes	Hygiene 99,9%	Yes
Full express - 60 minutes	Yes		

Options



Delay timer option	3-6-9 hours	Extra dry option	Yes
--------------------	-------------	------------------	-----

Baskets



Basket colour	Grey	Largest loadable dish in upper basket	25,0 cm
Basket components colour	Grey	Lower Basket	With 2 foldable racks
Handle	In plastic on upper and lower basket	Lower basket with anti-drip inserts	Yes
Upper Basket	With 1 foldable rack	Largest loadable dish in lower basket	30,0 cm
Glass holder	Yes	Colour Inner Components	Grey
Height adjustment of the upper basket	On three levels (5 cm)	Cutlery basket	Yes
Upper basket with EasyGlide System	Yes		

Technical Features



Width (mm)	598 mm
Depth (mm)	600 mm
Product Height (mm)	848 mm
Controls	Electronic
Programme graphics	Symbols
Salt light indicator	Light
Rinse aid indicator	Light
End of cycle indicator	Led on display, with acoustic signal
Washing system	Orbital
Third spray arm	Single
Water softener	With electronic setting
Flood protection system	Total Acquastop

Water supply	Single; cold/hot water max. 60°C - energysave with hot water up to 35%
Max water hardness	100°fH;58°dH
Drying system	Natural condenser drying, with Dry Assist + automatic door opening system at the end of the cycle
Tub material	Stainless steel
Filter	Stainless steel
Concealed heating element	Yes
Hinges	Self balancing with fixed hinges
Adjustable feet	Just for levelling
Back cover	Yes, with covered counterweight
Depth of dishwasher with open door (mm)	1168
Removable top	Yes, with optional KIT
Top cover	In plastic

Performance / Energy Label - Reg. 2019



Energy Efficiency Class	C
Energy consumption [per 100 cycles, based on the eco programme]	73 kWh
Rated capacity (ps)	13
Water consumption [per cycle]	8,5 litres

Programme duration	4:40 h:min
Airborne acoustical noise emissions	45 dB(A) re 1 pW
Airborne acoustical noise emission class	C
Energy efficiency Index (EEI)	43,8

Electrical Connection

Plug	(F;E) Schuko
Connected power	1800 W
Current	10 A
Voltage	220-240 V

Frequency (Hz)	50 Hz
Type of connection	Single-phase
Power supply cable length	140 cm

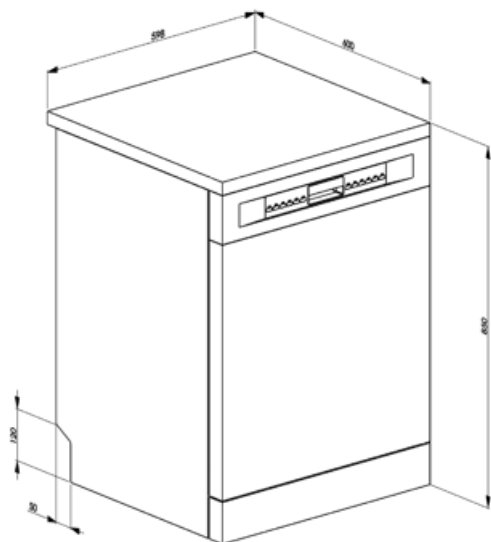

Not included accessories

KITINC



KITGH

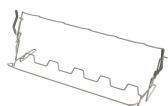















Kit glass holder. It has to be fitted on the first basket but only if there are foldable racks

KITPLV2



Kit extension for dishwasher and washing machine: lenght mt. 2

Symbols glossary (TT)

 To improve the drying of dishes without leaving stains.	 Delay Timer: Option to postpone the start of the desired programme by up to 24 hours in order to programme the dishwasher to run at the desired time.
 EasyGlide: Convenient EasyGlide system for easy unloading of the appliance that allows reaching maximum flexibility of load of the machine.	 Noise Level: Excellent insulation and special devices keep noise to a minimum.
 Orbital wash system distributes water evenly throughout the 60cm dishwasher cavity, directing water with precision to ensure an excellent wash.	 Crystals: The Crystals programme is dedicated to delicate dishes such as glasses and china.
 Eco: Eco, this economic wash programme uses a low amount of water and energy in order to provide the most environmentally friendly cleaning option.	 Mix: The Mix programme is suitable for mixed crockery and everyday pots and pans, without any particular incrustation.
 13 place settings: Number of place settings.	 Total Acquastop: In addition to the partial Acquastop protection present in all Smeg dishwashers, some models have an electronic device fitted to the water intake hose, which monitors water levels in the machine, detects leaks in the hose and switches off the water supply immediately when necessary.
 System WaterSave ensures the best washing results with minimal water consumption depending on the model of dishwasher.	 EXTRA DRY This option adds a hot rinse cycle that ensures improved drying.
 Quick wash cycle for normally soiled mixed loads such as dishes and pans, even with dried-on residues. Dishes are washed and dried in 60 minutes.	 Energy efficiency class C
 HYGIENE 99.9% High-temperature washing programme. The 75° rinse guarantees the removal of 99.9% of germs and bacteria.	