

# LVS3222BIN

|                   |               |
|-------------------|---------------|
| Product Family    | Dishwashers   |
| Width             | 60 cm         |
| Commercial height | 85 cm         |
| Installation      | Free-standing |
| N° baskets        | 2             |
| EAN code          | 8017709253844 |



## Programmes



|                      |                           |                 |     |
|----------------------|---------------------------|-----------------|-----|
| No. of programmes    | 5+5 quick programmes      | Normal          | Yes |
| Washing temperatures | 38, 45, 50, 55, 65, 70 °C | Ultraclean      | Yes |
| Soak                 | Yes                       | ECO Quick       | Yes |
| Rapid 27'            | Yes                       | Normal Quick    | Yes |
| Glass                | Yes                       | Strong and fast | Yes |
| ECO                  | Yes                       |                 |     |

## Options



|                                  |  |                               |     |
|----------------------------------|--|-------------------------------|-----|
| Energy saving option<br>EnerSave | Yes                                    | Options for tabs<br>FlexiTabs | Yes |
| Delay timer option               | 3-6-9-12 hours, with<br>automatic soak | Quick Time option             | Yes |

## Baskets



|                             |   |  |                       |
|-----------------------------|---|--|-----------------------|
| Basket colour               | Grey                                    | Lower Basket                             | With 2 foldable racks |
| Basket components<br>colour | Grey                                    | Lower basket with anti-<br>drip inserts  | Yes                   |
| Handle                      | In plastic on upper and<br>lower basket | Largest loadable dish in<br>lower basket | 30,0 cm               |
| Upper Basket                | With central fixed racks                |  |                       |

|  |                 |                                |   |
|--|-----------------|--------------------------------|---|
| <b>Height adjustment of the upper basket</b> | On three levels | <b>Colour Inner Components</b> | Grey anti drop inserts, Grey handles, Grey pastic plate for regulation second basket on three levels, Green Orbital |
| <b>Largest loadable dish in upper basket</b> | 23,5 cm         | <b>Cutlery basket</b>          | 13 place settings sliding   |

## Technical Features



|                               |                                  |  |   |
|-------------------------------|----------------------------------|--|---|
| <b>Width (mm)</b>             | 598 mm                           | <b>Water softener</b>                          | With electronic setting   |
| <b>Depth (mm)</b>             | 600 mm                           | <b>Flood protection system</b>                 | Total Acquastop   |
| <b>Display type</b>           | LED (external)                   | <b>Water supply</b>                            | Single; cold/hot water max. 60°C - energysave with hot water up to 35%                        |
| <b>Product Height (mm)</b>    | 848 mm                           | <b>Max water hardness</b>                      | 100°FH;58°dH  |
| <b>Controls</b>               | Electronic                       | <b>Drying system</b>                           | Natural condenser drying, with EnerSave automatic door opening system at the end of the cycle |
| <b>Display</b>                | Delayed start                    | <b>Tank material</b>                           | Stainless steel   |
| <b>Programme graphics</b>     | Symbols                          | <b>Filter</b>                                  | Stainless steel   |
| <b>On/off indicator</b>       | Yes                              | <b>Concealed heating element</b>               | Yes   |
| <b>Salt light indicator</b>   | Light                            | <b>Hinges</b>                                  | Self balancing with fixed hinges  |
| <b>Rinse aid indicator</b>    | Light                            | <b>Adjustable feet</b>                         | Just for levelling  |
| <b>Progress indicator</b>     | Yes                              | <b>Back cover</b>                              | Yes, with covered counterweight   |
| <b>End of cycle indicator</b> | On display, with acoustic signal | <b>Depth of dishwasher with open door (mm)</b> | 1168  |
| <b>Washing system</b>         | Orbital                          | <b>Removable top</b>                           | Yes, with optional KIT  |
| <b>Third spray arm</b>        | Single                           |  |   |

## Electrical Connection

|                        |              |                                  |              |
|------------------------|--------------|----------------------------------|--------------|
| <b>Plug</b>            | (F;E) Schuko | <b>Frequency (Hz)</b>            | 50 Hz        |
| <b>Connected power</b> | 1800 W       | <b>Type of connection</b>        | Single-phase |
| <b>Current</b>         | 10 A         | <b>Power supply cable length</b> | 140 cm       |
| <b>Voltage</b>         | 220-240 V    |                                  |              |

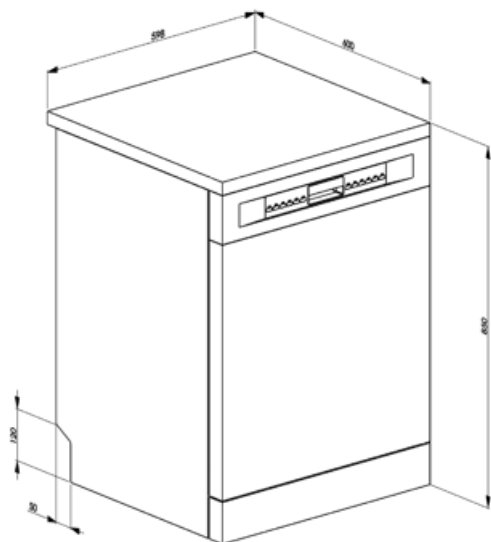

---

## Not included accessories

---

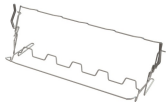

### KITGH

Kit glass holder. It has to be fitted on the first basket but only if there are foldable racks

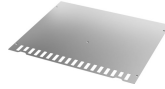

### KITINC















a steel bar fitted on the top will block the dishwasher at the top.



### KITPLV2

Kit extension for dishwasher and washing machine: length mt. 2

## Symbols glossary

|   |   |
|---|---|
|  <p>Anti-drip: Some models of dishwashers are equipped with special polymer nozzles anti-drip, that improve the process of drying.</p>                      |  <p>A++: Energy efficiency class A++ helps to save up to 20% energy compared to class A. Maximum performance with minimum consumption is guaranteed.</p>   |
|  <p>Delay Timer: The delay timer can postpone the start of the program by up to 24 hours.</p>   |  <p>LED display: to show programmes, functions and options selected and the time to the end of the cycle.</p>  |
|  <p>Flexitabs: Flexitabs adjusts the wash cycle to give the best possible results regardless of the type of detergent used.</p>                             |  <p>Noise Level: Excellent insulation and special devices keep noise to a minimum.</p>   |
|  <p>Orbital wash system distributes water evenly throughout the 60cm dishwasher cavity, directing water with precision to ensure an excellent wash.</p>     |  <p>Eco: Eco, this economic wash programme uses a low amount of water and energy in order to provide the most environmentally friendly cleaning option.</p>  |
|  <p>Eco: Eco, this economic wash programme uses a low amount of water and energy in order to provide the most environmentally friendly cleaning option.</p> |  <p>Normal Quick: Program Normal Quick is suitable for quick washing of mixed dishes, for everyday use.</p>  |
|  <p>Soak programme: The soak programme provides a rinse to prevent dirt from drying.</p>  |  <p>Strong&amp;Fast: This special programme takes less than 1 hour to eliminate the most stubborn dirt and dried on residues.</p>  |
|  <p>The symbols show the number of plate settings of the dishwasher.</p>  |  <p>Total Acquastop: In addition to the partial Acquastop protection present in all Smeg dishwashers, some models have an electronic device fitted to the water intake hose, which monitors water levels in the machine, detects leaks in the hose and switches off the water supply immediately when necessary.</p> |
|  <p>System WaterSave ensures the best washing results with minimal water consumption depending on the model of dishwasher.</p>                            |   |