

LVS344PM



Product Family	Dishwashers
Width	60 cm
Commercial height	85 cm
Installation	Free-standing
N° baskets	3, FlexiDuo
Motor	Inverter 2.0
Type	Semi professional
EAN code	8017709307356



Programmes



No. of programmes	10+1	Auto sensor 45-65	Yes
Washing temperatures	45, 50, 65, 70, 75 °C	Mix	Yes
Soak	Yes	Intense	Yes
Crystal	Yes	Self clean	Yes
Full express - 60 minutes	Yes	Hygiene 99,9%	Yes
ECO	Yes	Ultra Express	Yes

Professional programs



Ultra rapid	Yes	Full express PRO	Yes
Mix PRO	Yes	Crystal Pro	Yes
Intensive Pro	Yes		

Options



Dry Assist+ option	Yes	1/2 load FlexiZone option (varied distribution)	Yes
Delay timer option	Up to 24 hours, with automatic soak	Professional option	Yes

Baskets



Basket colour	Grey	Sliding Guides Extra Glide	Yes
Basket components colour	Grey	Largest loadable dish in upper basket	19,0 cm
Handle	In plastic with stainless steel insert on upper and lower basket	Lower Basket	With 4 foldable racks
Upper Basket	With 3 foldable racks	Lower basket with anti-drip inserts	Yes
Glass holder	Yes	Largest loadable dish in lower basket	30,0 cm
Height adjustment of the upper basket	On three levels	Colour Inner Components	Blue

Technical Features



Width (mm)	598 mm	Turbidity sensor Aquatest	Yes
Depth (mm)	600 mm	Flood protection system	Total Acquastop
Display type	LED display	Water supply	Single; cold/hot water max. 60°C - energysave with hot water up to 35%
Product Height (mm)	850 mm	Max water hardness	100°FH;58°dH
Controls	Electronic	Drying system	Natural condenser drying, with Dry Assist + automatic door opening system at the end of the cycle
Display	Delayed start, Programme time indicator, Time to end indication	Tank material	Stainless steel
Programme graphics	Symbols	Filter	Stainless steel
Salt light indicator	Light	Concealed heating element	Yes
Rinse aid indicator	Light	Hinges	Self balancing with fixed hinges
Progress indicator	Yes	Adjustable feet	Just for levelling
End of cycle indicator	On display, with acoustic signal	Back cover	Yes
Auto switch-off	Yes	Depth of dishwasher with open door (mm)	1168 mm
Washing system	Planetarium	Removable top	Yes, with optional KIT
Third spray arm	Single	Top cover	In plastic
Water softener	With electronic setting		

Performance / Energy Label



Energy Efficiency Class (Washing cycle)	C	Programme duration	4:25 h:min
Energy consumption [per 100 cycles, based on the eco programme]	75 kWh	Airborne acoustical noise emissions (spinning phase)	44 dB(A) re 1 pW
Rated capacity (ps)	14	Airborne acoustical noise emission class	B
Water consumption [per cycle]	10.5 litres	Energy efficiency Index (EEI) (Washing cycle)	43.8

Electrical Connection

Connected power 5450 W
Current 32 A
Voltage 220-240 V
Frequency (Hz) 50 Hz

Type of connection Single-phase
Power supply cable length 200 cm
Plug No

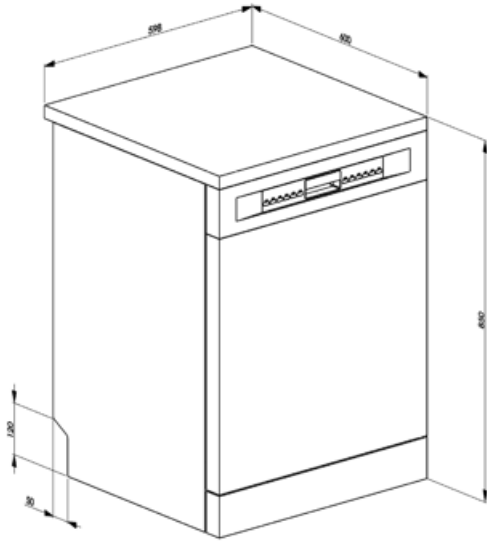

Compatible Accessories



KITGH

Kit glass holder. It has to be fitted on the first basket but only if there are foldable racks



KITINC























a steel bar fitted on the top will block the dishwasher at the top.



KITPLV2

Kit extension for dishwasher and washing machine: length mt. 2

Symbols glossary

 <p>Aquatest measures the clarity of the water during an auto program, and automatically ensures the minimum consumption of water and energy.</p>	 <p>Anti-drip: Some models of dishwashers are equipped with special polymer nozzles anti-drip, that improve the process of drying.</p>
 <p>Delay Timer: The delay timer can postpone the start of the program by up to 24 hours.</p>	 <p>FlexiDuo: The FlexiDuo 3rd cutlery basket allows you to arrange cutlery or small cups, ladles, or bulky utensils however you like: it consists of two separate and moveable modules.</p>
 <p>FlexiZone: The ½ load flexizone allows you to wash a reduced load saving energy, water and time and there are no restrictions on where the items are placed.</p>	 <p>The new ExtraGlide guide system, available on top of the range models, makes the second basket even smoother and softer. In fact, it facilitates the extraction of the introduction, even at full load and, for the greater excursion, the insertion of crockery is also facilitated in the rear part.</p>
 <p>Noise Level: Excellent insulation and special devices keep noise to a minimum.</p>	 <p>PLANETARIUM_WASHING_SYSTEM_72dpi</p>
 <p>Auto 45°- 65°: The auto programme regulates the length of a cycle depending on the need for a pre-wash and the number of rinses required.</p>	 <p>Crystals: The Crystals programme is dedicated to delicate dishes such as glasses and china.</p>
 <p>Eco: Eco, this economic wash programme uses a low amount of water and energy in order to provide the most environmentally friendly cleaning option.</p>	 <p>IntensivoProf: The Intensive program is recommended for heavily soiled pots and pans and dry residues to be washed quickly.</p>
 <p>Normal programme: The normal programme is suitable for normal degrees of dirt for everyday use.</p>	 <p>Soak programme: The soak programme provides a rinse to prevent dirt from drying.</p>
 <p>Ultra Rapid: The program is specifically for Ultra Fast wash very quickly (16 min.). Pots and pans very dirty, even with dried residues.</p>	 <p>Ultraclean: The Ultraclean option performs a final rinse at a high temperature of 70°C eliminating virtually all bacteria.</p>
 <p>Professional: Option Professional enables to convert household appliances into semiprofessional ones due to the programs which significantly reduce washing time to obtain an astonishing 16 minutes cycle.</p>	 <p>Quick Time: The Quick Time option can reduce the length of the wash cycle up to 55%.</p>
 <p>The symbols show the number of plate settings of the dishwasher.</p>	 <p>Total Acquastop: In addition to the partial Acquastop protection present in all Smeg dishwashers, some models have an electronic device fitted to the water intake hose, which monitors water levels in the machine, detects leaks in the hose and switches off the water supply immediately when necessary.</p>
 <p>System WaterSave ensures the best washing results with minimal water consumption depending on the model of dishwasher.</p>	 <p>Quick wash cycle for normally soiled mixed loads such as dishes and pans, even with dried-on residues. Dishes are washed and dried in 60 minutes.</p>



Dishwasher cleaning cycle. The cycle should be started with the machine empty, without dishes. It is recommended to run the program every 2-3 months, using special dishwasher detergents.



The Dry Assist + option, in addition to saving energy, ensures perfect drying of the dishes by opening the door automatically at the end of the wash cycle.



HYGIENE 99.9% High-temperature washing programme. The 75° rinse guarantees the removal of 99.9% of germs and bacteria, making it ideal for sanitising.



Special quick program for washing glasses.



Energy efficiency class C



The work aimed at continuous improvement has allowed the creation of the second generation of the Inverter motor 2.0, characterised by greater efficiency and durability over time, which allows very high performance and a lower energy consumption and noise level.



Benefit

FlexiDuo

For added convenience, the flexible third basket—FlexiDuo—adapts to accommodate various types of dishes, giving you extra space and better organisation with every load

The third FlexiDuo basket consists of two separate sections that can be handled independently of each other, stacked and/or removed, offering loading flexibility for every need. Depending on the arrangement, it allows cups, tall glasses, bulky utensils and pots and pans to be placed in the upper basket.

Planetarium Wash System

Smeg's unique Planetarium Wash System uses a specially designed spray arm to deliver full, deep cleaning coverage across every corner of the dishwasher

Smeg's patented Planetarium Wash System guarantees impeccable cleaning. With a simultaneous double movement of the sprayer and 65 rotations per minute, it reaches every nook and cranny for extraordinary results. Dishes, glasses and utensils will be perfectly clean in no time. An intelligent system where efficiency and style meet, delivering brilliant results effortlessly.

Extra Glide Telescopic Guides

Smoother and more stable loading and unloading operations

Extra Glide telescopic guides ensure smooth and safe extraction of the upper basket, even with heavy loads. The telescopic design ensures smooth, stable and silent movement, improving ergonomics and convenience. Ideal for optimising space and ease of use, they combine durability and comfort in every washing operation.

DryAssist+

At the end of the cycle, the Dry Assist+ feature automatically opens the door to speed up drying and improve energy efficiency