

LVS345BQSTX



Product Family	Dishwashers
Commercial width	60 cm
Commercial height	85 cm
Installation	Free-standing
N° baskets	3, FlexiDuo with Easy Glide
Motor	Inverter 2.0
EAN code	8017709334024



Programs



N. of programmes	10+1	Auto sensor 45-65	Yes
Washing temperatures	38, 45, 50, 55, 65, 70, 75 °C	Mix	Yes
Soak	Yes	Quiet (-2 dB)	Yes
Express 27'	Yes	Intense	Yes
Crystal	Yes	Self clean	Yes
Full express - 60 minutes	Yes	Hygiene 99,9%	Yes
ECO	Yes		

Options



Dry Assist+ option	Yes	Intensive wash zone option	Yes
Delay timer option	Up to 24 hours	Special programs option	Yes
1/2 load FlexiZone option	Yes		

Baskets



Basket colour	Grey	Upper basket with EasyGlide System	Yes
Basket components colour	Grey	Largest loadable dish in upper basket	19,0 cm

Handle	In plastic with stainless steel insert on upper and lower basket	Lower Basket	With 4 foldable racks
Upper Basket	With 3 foldable racks	Lower basket with anti-drip inserts	Yes
Glass holder	Yes	Largest loadable dish in lower basket	30,0 cm
Height adjustment of the upper basket	On three levels (5 cm)	Colour Inner Components	Blue

Technical Features



Width (mm)	598 mm	Turbidity sensor Aquatest	Yes
Depth (mm)	600 mm	Flood protection system	Total Acquastop
Display type	LED display (3 digit)	Water supply	Single; cold/hot water max. 60°C - energysave with hot water up to 35%
Product Height (mm)	848 mm	Max water hardness	100°FH;58°dH
Controls	Electronic touch control	Drying system	Natural condenser drying, with Dry Assist + automatic door opening system at the end of the cycle
Display	Delayed start, Programme time indicator, Time to end indication	Tub material	Stainless steel
Programme graphics	Symbols	Filter	Stainless steel
On/off indicator	Yes	Concealed heating element	Yes
Salt light indicator	Light	Hinges	Self balancing with fixed hinges
Rinse aid indicator	Light	Adjustable feet	Just for levelling
End of cycle indicator	Led on display, with acoustic signal	Back cover	Yes, with covered counterweight
Washing system	Planetarium	Depth of dishwasher with open door (mm)	1168 mm
Third spray arm	Single	Removable top	Yes, with optional KIT
Water softener	With electronic setting		

Performance / Energy Label - Reg. 2019

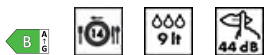

Energy Efficiency Class	B	Programme duration	4:25 h:min
Energy consumption [per 100 cycles, based on the eco programme]	64 kWh	Airborne acoustical noise emissions	44 dB(A) re 1 pW
Rated capacity (ps)	14	Airborne acoustical noise emission class	B
Water consumption [per cycle]	9,0 litres	Energy efficiency Index (EEI)	37,8

Electrical Connection

Connected power	1800 W	Type of connection	Single-phase
------------------------	--------	---------------------------	--------------

Current	10 A	Power supply cable length	140 cm
Voltage	220-240 V	Plug	(F;E) Schuko
Frequency (Hz)	50 Hz		

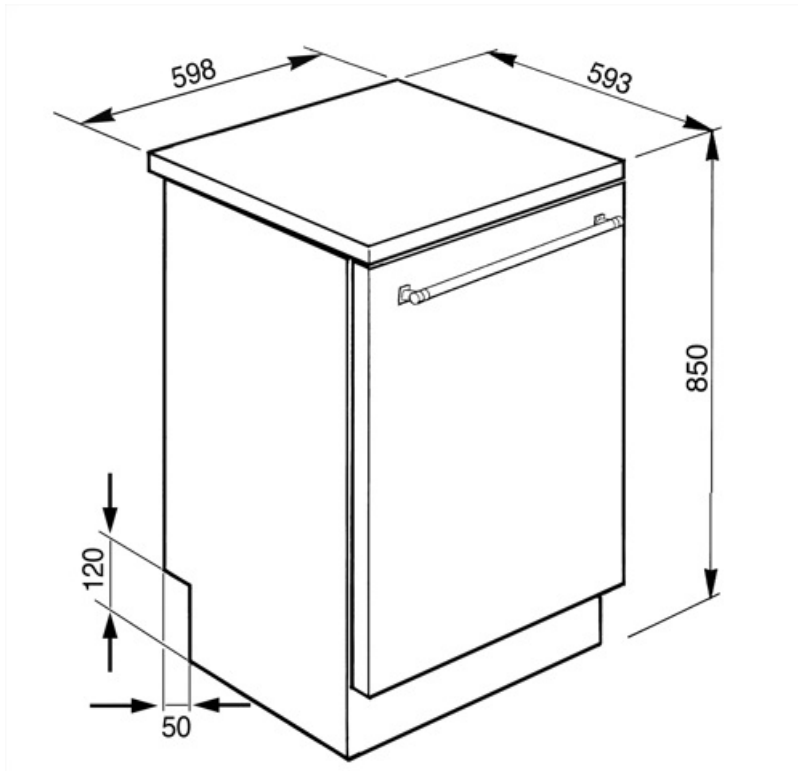

Compatible Accessories



KITGH

Kit glass holder. It has to be fitted on the first basket but only if there are foldable racks























KITINC











KITPLV2

Kit extension for dishwasher and washing machine: lenght mt. 2

Symbols glossary

	<p>The Aquatest sensor is an electronic sensor that measures the degree of water transparency at the end of the initial soaking phase. Used on the values measured, the sensor sets the most suitable programme, thus obtaining the best washing results with the minimum amount of water.</p>		<p>To improve the drying of dishes without leaving stains.</p>
	<p>Energy efficiency class B</p>		<p>Delay Timer: Option to postpone the start of the desired programme by up to 24 hours in order to programme the dishwasher to run at the desired time.</p>
	<p>The Dry Assist + option, in addition to saving energy, ensures perfect drying of the dishes by opening the door automatically at the end of the washing cycle.</p>		<p>EasyGlide: Convenient EasyGlide system for easy unloading of the appliance that allows reaching maximum flexibility of load of the machine.</p>
	<p>FlexiDuo: The FlexiDuo 3rd cutlery basket allows you to arrange cutlery or small cups, ladles, or bulky utensils however you like: it consists of two separate and moveable modules.</p>		<p>FlexiZone: The ½ load flexizone allows you to wash a reduced load saving energy, water and time and there are no restrictions on where the items are placed.</p>
	<p>Noise Level: Excellent insulation and special devices keep noise to a minimum.</p>		<p>The work aimed at continuous improvement has allowed the creation of the second generation of the Inverter motor 2.0, characterised by greater efficiency and durability over time, which allows very high performance and a lower energy consumption and noise level.</p>
	<p>Noise Level: Excellent insulation and special devices keep noise to a minimum.</p>		<p>The Planetarium washing system, with high rotations per minute, guarantees complete coverage of the tank, thanks to the simultaneous rotation of base and sprayers, and excellent washing results.</p>
	<p>Auto 45°- 65°: The auto programme regulates the length of a cycle depending on the need for a pre-wash and the number of rinses required.</p>		<p>Crystals: The Crystals programme is dedicated to delicate dishes such as glasses and china.</p>
	<p>Eco: Eco, this economic wash programme uses a low amount of water and energy in order to provide the most environmentally friendly cleaning option.</p>		<p>Quick wash cycle for normally soiled mixed loads such as dishes and pans, even with dried-on residues. Dishes are washed and dried in 60 minutes.</p>
	<p>Mix: The Mix programme is suitable for mixed crockery and everyday pots and pans, without any particular incrustation.</p>		<p>Soak programme: The soak programme provides a rinse to prevent dirt from drying.</p>
	<p>Express 27': The Express 27' programme is a quick wash cycle, at low temperatures, for lightly soiled dishes.</p>		<p>Ultraclean: The Ultraclean option performs a final rinse at a high temperature of 70°C eliminating virtually all bacteria.</p>

-
- | | |
|---|--|
|  14 place settings: Number of place settings. |  Total Acquastop: In addition to the partial Acquastop protection present in all Smeg dishwashers, some models have an electronic device fitted to the water intake hose, which monitors water levels in the machine, detects leaks in the hose and switches off the water supply immediately when necessary. |
|  Touch controls: Easy to use touch controls allow the appliance to be programmed at the touch of a button. |  System WaterSave ensures the best washing results with minimal water consumption depending on the model of dishwasher. |
|  Dishwasher cleaning cycle. The cycle should be started with the machine empty, without dishes. It is recommended to run the program every 2-3 months, using special dishwasher detergents. |  SILENT: Wash cycle suitable for normally soiled dishes, even with dried-on residues. Ensures maximum noise reduction and is therefore ideal if you wish to run it during the night. |
|  Allows you to enable additional programs when selected together with any wash cycle. |  HYGIENE 99.9% High-temperature washing programme. The 75° rinse guarantees the removal of 99.9% of germs and bacteria. |