

LVSP345BQX



Familie	Vaatwasser
Commerciële breedte	60 cm
Nishoogte	85 cm
Installatie	Vrijstaand
Aantal korven	3, FlexiDuo met Easy Glide
EAN-code	8017709307295



Programs



Aantal programma's	10+1	Auto sensor 45-65	Ja
Wastemperatuur	38, 45, 50, 55, 65, 70, 75 °C	Mix	Ja
Weken	Ja	Stil (-2dB)	Ja
Snel 27'	Ja	Intensief	Ja
Krystal	Ja	Zelf reinigen	Ja
Snel - Volledig 60'	Ja	Hygiëne 99,9%	Ja
Eco	Ja		

Opties



Dry Assist + opties	Ja	FlexiZone ½ (halve beladingsmogelijkheid)	Ja
Delay timer optie	Tot 24 uur, i.c.m. automatisch spoelen	Optie speciale programma's	Ja

Korven



Kleur korven	Grijs	Bovenmand met EasyGlide System:	Ja
Kleur korfcomponenten	Grijs		
Handgreep	Van kunststof met roestvrijstalen inzet op boven- en onderrek		
Bovenkorf	Met 3 opvouwbare rekken		

Glazen houder	Ja	Maximum afmetingen bord dat in bovenste korf kan worden geladen	19,0 cm
In hoogte verstelbare bovenkorf	3 niveaus	Onderkorf	Met 4 opvouwbare rekken
		Onderkorf met anti-drup inserts	Ja
		Maximum afmetingen bord dat in onderste korf kan worden geladen	30,0 cm
		Kleur binnenonderdelen	Blauw

Technische specificaties



Breedte product	598 mm	Waterontkalker	Elektronisch instelbaar
Diepte product	600 mm	Aquatest sensor	Ja
Type display	OLED	Overstroombeveiliging	Total Acquastop
Hoogte product	848 mm	Watertoevoer	Enkel; koud en warm water tot 60°C - energiebesparing tot 35%
Bediening	Elektronisch	Maximale waterhardheid	100°FH;58°dH
Display	Instelling Delay timer, Programma duur indicator, Resttijd indicatie, Dynamics programme time indicator	Droogstelsysteem	Natuurlijk condensor drogen met Dry Assist + automatische deuropeningssysteem aan het einde van de cyclus
Grafische weergave programma's	Symbolen	Materiaal kuip	Roestvrij staal
Aan/uit indicator	Ja	Filter	Roestvrij staal
Zout indicator	Indicator (lampje)	Verborgen verwarmingselement	Ja
Glansspoelmiddel indicator	Indicator (lampje)	Scharnieren	Zelfbalancerend met vast steunpunt
Indicator einde cyclus	Op display, met akoestisch signaal	Verstelbare voetjes	Alleen voor niveau aanpassing
Auto switch-off	Yes	Back cover	Yes, with covered counterweight
Wassysteem	Planetarium	Diepte vaatwasser met open deur (mm)	1168 mm
Derde sproeiarm	Enkel	Verwijderbare bovenkant	Ja, met optionele KIT

Performance / Energy Label - Reg. 2019

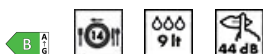

Energie-efficiëntieklasse B (wascyclus)	Programmaduur	4:25 h:min
	Geluidsniveau	44 dB(A) re 1 pW
	Akoestisch geluidsemissieklasse	B

Energy consumption 64 kWh
[per 100 cycles, based
on the eco programme]

Energy efficiency Index 37,8
(EEI)

Nominale capaciteit (ps) 14
Water verbruik (per
cyclus) 9,0 litres

Elektrische aansluiting

Aansluitwaarde 1800 W
Stroom 10 A
Spanning 220-240 V
Frequentie 50 Hz

Type aansluiting Single-phase
Lengte voedingskabel 140 cm
Stekker (F;E) Schuko

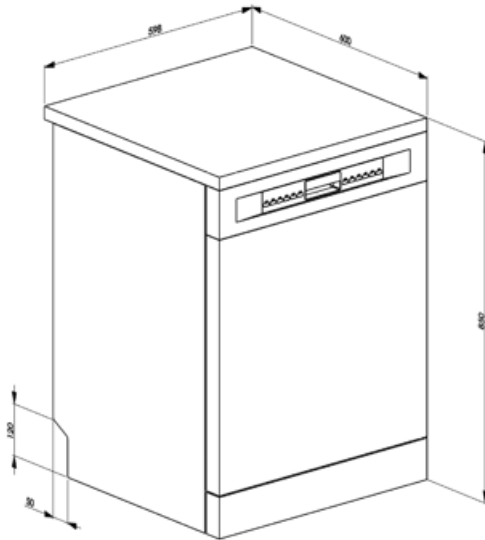

Compatibele Accessoires

KITGH



Kit glazen houder. Deze moet op de eerste mand worden gemonteerd, maar alleen als er inklapbare rekken zijn

KITPLV2

























Kit verlengstuk voor vaatwasser en wasmachine: lengte 2 mtr.

KITINC



Symbols glossary

	Aquatest meet de helderheid van het water tijdens een automatisch programma en zorgt automatisch voor een minimaal verbruik van water en energie		To improve the drying of dishes without leaving stains.
	Energy efficiency class B		Vertragingstimer: De uitgestelde timer kan de start van het programma tot 24 uur uitstellen.
	LED-display: toont de geselecteerde programma's, functies en opties en de tijd tot het einde van de cyclus.		The Dry Assist + option, in addition to saving energy, ensures perfect drying of the dishes by opening the door automatically at the end of the washing cycle.
	EasyGlide: handig EasyGlide-systeem voor eenvoudig uitladen van het apparaat en dat maximale flexibiliteit van het laden van de machine mogelijk maakt		FlexiDuo: The FlexiDuo 3rd cutlery basket allows you to arrange cutlery or small cups, ladles, or bulky utensils however you like: it consists of two separate and moveable modules.
	FlexiZone: The ½ load flexizone allows you to wash a reduced load saving energy, water and time and there are no restrictions on where the items are placed.		Noise Level: Excellent insulation and special devices keep noise to a minimum.
	The Planetarium washing system, with high rotations per minute, guarantees complete coverage of the tank, thanks to the simultaneous rotation of base and sprayers, and excellent washing results.		Auto 45°- 65°: The auto programme regulates the length of a cycle depending on the need for a pre-wash and the number of rinses required.
	Crystals: The Crystals programme is dedicated to delicate dishes such as glasses and china.		Eco: Eco, this economic wash programme uses a low amount of water and energy in order to provide the most environmentally friendly cleaning option.
	Mix: The Mix programme is suitable for mixed crockery and everyday pots and pans, without any particular incrustation.		Soak programme: The soak programme provides a rinse to prevent dirt from drying.
	Express 27': The Express 27' programme is a quick wash cycle, at low temperatures, for lightly soiled dishes.		Ultraclean: The Ultraclean option performs a final rinse at a high temperature of 70°C eliminating virtually all bacteria.
	14 place settings: Number of place settings.		Total Acquastop: In addition to the partial Acquastop protection present in all Smeg dishwashers, some models have an electronic device fitted to the water intake hose, which monitors water levels in the machine, detects leaks in the hose and switches off the water supply immediately when necessary.
	System WaterSave ensures the best washing results with minimal water consumption depending on the model of dishwasher.		Quick wash cycle for normally soiled mixed loads such as dishes and pans, even with dried-on residues. Dishes are washed and dried in 60 minutes.



Dishwasher cleaning cycle. The cycle should be started with the machine empty, without dishes. It is recommended to run the program every 2-3 months, using special dishwasher detergents.



Allows you to enable additional programs when selected together with any wash cycle.



The work aimed at continuous improvement has allowed the creation of the second generation of the Inverter motor 2.0, characterised by greater efficiency and durability over time, which allows very high performance and a lower energy consumption and noise level.



SILENT: Wash cycle suitable for normally soiled dishes, even with dried-on residues. Ensures maximum noise reduction and is therefore ideal if you wish to run it during the night.



HYGIENE 99.9% High-temperature washing programme. The 75° rinse guarantees the removal of 99.9% of germs and bacteria.

