

LZ102A2

Sink material	Composite
Type	Composite sink
No. of bowls	1 + 1/2
Drainer	Reversible
EAN code	8017709251680



Aesthetics



Aesthetic	Universale	Logo	Applied/on overflow
Colour	Anthracite	Alternative colours available	White, Cream, Beige, Copper, Cemento / Concrete
Series	Rigae	Half bowl cup drainer	Yes
Building in type	Standard	Tap hole / precut tap hole	Prepared

	Bowl type RH	Bowl dimensions, WxDxH (mm)	Bowl depth (mm)	Radius corner right bowl (mm)	Overflow LH bowl	Strainer position	Strainer dimension
RH Bowl	Half bowl	150 x 340 x 168	168	50		Centre of bowl	3.5"
LH Bowl	Traditional	420 x 320 x 210	210	80	Yes, traditional	Side bowl	3.5"

Technical Features



Characteristics composite material	Antibacterial, Easy to clean, Anti-scratch, Thermal shock resistant, High temperatures resistant, Impact resistant, UV Resistant	Tap hole	2
Frame depth (mm)	10	Tap hole diameter	35 mm
		Dividing wall width	38 mm
		Drainer inclination	2 °
		No. of clips	10
		Type of clips	Standard

Dimensions of the product (mm)	210x1000x500 mm	Possibility to install waste disposal	Yes
Cutout dimension topmount (mm)	980 X 480 mm		
Undermount cutout radius	30 mm		
Height from kitchen top	10 mm		
Base unit size	60 cm		

Accessories included

Accessories for installation	Strainer, Savespace siphon with dishwasher outlet connection, Fixing clips
------------------------------	--

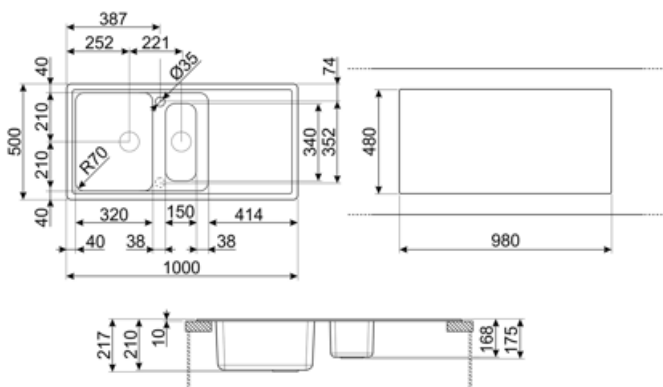

Compatible Accessories



KITDSQ

Soap dispenser chrome finishing with square knob 40x40 mm



KITFD075

Waste disposal 0,75 HP, Motor: 1/2 horsepower, Fits all sinks with 3 1/2" waste outlet



KITFD050

Waste disposal 0,5 HP, Motor: 1/2 horsepower, Fits all sinks with 3 1/2" waste outlet



KITFD100

Waste disposal 1 HP, Motor: 1/2 horsepower, Fits all sinks with 3 1/2" waste outlet

Alternative products

LZ102CT

Colour: Cement / Concrete



LZ102B

Colour: White



LZ102AV2

Colour: Oats















LZ102P

Colour: Cream



Symbols glossary

	Cupboard width required for sink installation.		Sink depth - depending on the model, the depth can be from 13 to 24,5.
	Sink depth - depending on the model, the depth can be from 13 to 24,5.		Standard installation: Traditional installation in tabletop, suitable for any kitchen sets.
	Antibacterial		Antiscratch
	Thermal shock resistant		High temperatures resistant
	Impact resistant		Easy to clean
	Thanks to the double tap hole, most of our sinks are easily reversible, giving you the flexibility to make any type of kitchen composition.		UV protection, does not fade over time.