

LZ102B

| | |
|---------------|----------------|
| Sink material | Composite |
| Sink type | Synthetic sink |
| No. of bowls | 1 + 1/2 |
| Drainer | Reversible |
| EAN code | 8017709182816 |

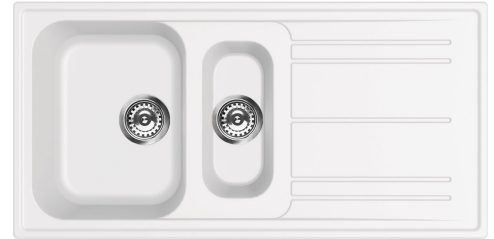

Aesthetics



| | | | |
|-------------------------|-----------|--------------------------------------|--|
| Aesthetics | Universal | Logo | Applied/on overflow |
| Series | Rigae | Alternative colours available | Anthracite, Cream, Beige, Copper, Cemento / Concrete |
| Colour | White | Tap hole / precut tap hole | Prepared |
| Building in type | Standard | | |

| | Bowl type | Bowl dimensions, WxDxH (mm) | Bowl depth (mm) | Radius corner right bowl (mm) | Overflow LH bowl | Strainer position | Strainer dimension |
|---------|-------------|-----------------------------|-----------------|-------------------------------|------------------|-------------------|--------------------|
| RH Bowl | Half bowl | 150 x 340 x 168 | 168 | 50 | | Centre of bowl | 3.5" |
| LH Bowl | Traditional | 420 x 320 x 210 | 210 | 80 | Yes, traditional | Side bowl | 3.5" |

Technical Features



| | | | |
|---|---|----------------------------|----------|
| Characteristics composite material | Strainer, Pre-assembled gasket, Siphon with dishwasher outlet connection, Siphon save space with dishwasher outlet connection, Fixing clips, Gasket, UV Resistant | Tap hole | Yes |
| | | Tap hole diameter | 35 mm |
| | | Dividing wall width | 38 mm |
| | | Drainer inclination | 2 ° |
| | | No. of clips | 10 |
| Frame depth (mm) | 10 | Type of clips | Standard |

Not included accessories



KITFD050

Waste disposal 0,5 HP Motor: 1/2 horsepower Fits all sinks with 3 1/2" waste outlet



KITDSQ

Soap dispenser Square knob



KITFD100













Waste disposal 1 HP Motor: 1 horsepower Fits all sinks with 3 1/2" waste outlet



KITFD075

Waste disposal 0,75 HP Motor: 3/4 horsepower Fits all sinks with 3 1/2" waste outlet

Symbols glossary

| | | | |
|--|---|---|--|
|  | Cupboard width required for sink installation |  | Sink depth - depending on the model, the depth can be from 13 to 24,5 |
|  | Sink depth - depending on the model, the depth can be from 13 to 24,5 |  | Standard installation: Traditional installation in tabletop, suitable for any kitchen sets |
|  | Antibacterial |  | Antiscratch |
|  | Thermal shock resistant |  | High temperatures resistant |
|  | Impact resistant |  | Easy to clean |
|  | Thanks to the double tap hole, most of our sinks are easily reversible, giving you the flexibility to make any type of kitchen composition. |  | UV protection, does not fade over time. |