

LZ102CT

Sink material	Composite
Sink type	Synthetic sink
No. of bowls	1 + 1/2
Drainer	Reversible
EAN code	8017709251697

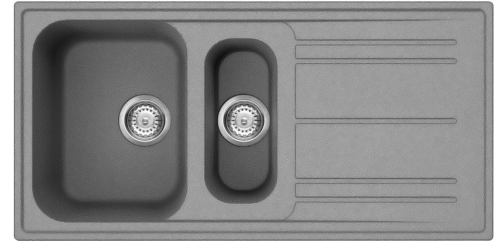

Aesthetics



Series	Rigae	Logo	Applied/on overflow
Aesthetics	Universal	Alternative colours available	White, Anthracite, Cream, Beige, Copper
Colour	Cement / Concrete	Half bowl cup drainer	Yes
Building in type	Standard	Tap hole / precut tap hole	Prepared

	Bowl type	Bowl dimensions, WxDxH (mm)	Bowl depth (mm)	Radius corner right bowl (mm)	Overflow LH bowl	Strainer position	Strainer dimension
RH Bowl	Half bowl	150 x 340 x 168	168	50		Centre of bowl	3.5"
LH Bowl	Traditional	420 x 320 x 210	210	80	Yes, traditional	Side bowl	3.5"

Technical Features



Characteristics composite material	Strainer, Siphon with dishwasher outlet connection, Siphon save space with dishwasher outlet connection, Fixing clips, Gasket, Pre-assembled gasket, UV Resistant	Tap hole	Yes
		Tap hole diameter	35 mm
		Dividing wall width	38 mm
		Drainer inclination	2 °
		No. of clips	10
		Type of clips	Standard

Frame depth (mm)	10
Dimensions of the product (mm)	210x1000x500 mm
Cutout dimension (mm)	980 X 480 mm
Cutout radius	30 mm
Height from kitchen top	10 mm
Base unit size	60 cm

Accessories Included

Accessories for installation	Strainer, Siphon with dishwasher outlet connection, Fixing clips
------------------------------	--

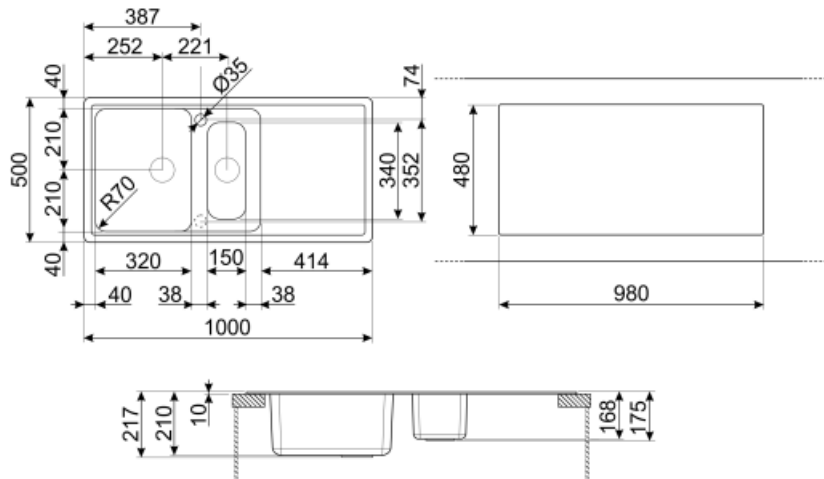

Not included accessories



KITFD050

Waste disposal 0,5 HP Motor: 1/2 horsepower Fits all sinks with 3 1/2" waste outlet



KITDSQ

Soap dispenser Square knob



KITFD050UK

Waste disposal 0,5 HP Motor: 1/2 horsepower Fits all sinks with 3 1/2" waste outlet



KITFD100

Waste disposal 1 HP Motor: 1 horsepower Fits all sinks with 3 1/2" waste outlet



KITFD075



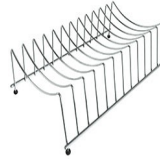









Waste disposal 0,75 HP Motor: 3/4 horsepower Fits all sinks with 3 1/2" waste outlet



COLPTX

Dranier accessory

Symbols glossary

	Cupboard width required for sink installation		Sink depth - depending on the model, the depth can be from 13 to 24,5
	Sink depth - depending on the model, the depth can be from 13 to 24,5		Standard installation: Traditional installation in tabletop, suitable for any kitchen sets
	Antibacterial		Antiscratch
	Thermal shock resistant		High temperatures resistant
	Impact resistant		Easy to clean
	Thanks to the double tap hole, most of our sinks are easily reversible, giving you the flexibility to make any type of kitchen composition.		UV protection, does not fade over time.